

**FLUKE®**

**12B**  
**18**  
**7 Series**  
Meters

Service Manual

## LIMITED WARRANTY & LIMITATION OF LIABILITY

Each Fluke product is warranted to be free from defects in material and workmanship under normal use and service. The warranty period for Models 7-300, 7-600, and 12B is two years and begins on the date of shipment. The warranty period for Model 18 is three years and begins on the date of shipment. Parts, product repairs and services are warranted for 90 days. This warranty extends only to the original buyer or end-user customer of a Fluke authorized reseller, and does not apply to fuses, disposable batteries or to any product which, in Fluke's opinion, has been misused, altered, neglected or damaged by accident or abnormal conditions of operation or handling. Fluke warrants that software will operate substantially in accordance with its functional specifications for 90 days and that it has been properly recorded on non-defective media. Fluke does not warrant that software will be error free or operate without interruption.

Fluke authorized resellers shall extend this warranty on new and unused products to end-user customers only but have no authority to extend a greater or different warranty on behalf of Fluke. Warranty support is available if product is purchased through a Fluke authorized sales outlet or Buyer has paid the applicable international price. Fluke reserves the right to invoice Buyer for importation costs of repair/replacement parts when product purchased in one country is submitted for repair in another country.

Fluke's warranty obligation is limited, at Fluke's option, to refund of the purchase price, free of charge repair, or replacement of a defective product which is returned to a Fluke authorized service center within the warranty period.

To obtain warranty service, contact your nearest Fluke authorized service center or send the product, with a description of the difficulty, postage and insurance prepaid (FOB Destination), to the nearest Fluke authorized service center. Fluke assumes no risk for damage in transit. Following warranty repair, the product will be returned to Buyer, transportation prepaid (FOB Destination). If Fluke determines that the failure was caused by misuse, alteration, accident or abnormal condition of operation or handling, Fluke will provide an estimate of repair costs and obtain authorization before commencing the work. Following repair, the product will be returned to the Buyer transportation prepaid and the Buyer will be billed for the repair and return transportation charges (FOB Shipping Point).

THIS WARRANTY IS BUYER'S SOLE AND EXCLUSIVE REMEDY AND IS IN LIEU OF ALL OTHER WARRANTIES, EXPRESS OR IMPLIED, INCLUDING BUT NOT LIMITED TO ANY IMPLIED WARRANTY OF MERCHANTABILITY OR FITNESS FOR A PARTICULAR PURPOSE. FLUKE SHALL NOT BE LIABLE FOR ANY SPECIAL, INDIRECT, INCIDENTAL OR CONSEQUENTIAL DAMAGES OR LOSSES, INCLUDING LOSS OF DATA, WHETHER ARISING FROM BREACH OF WARRANTY OR BASED ON CONTRACT, TORT, RELIANCE OR ANY OTHER THEORY.

Since some countries or states do not allow limitation of the term of an implied warranty, or exclusion or limitation of incidental or consequential damages, the limitations and exclusions of this warranty may not apply to every buyer. If any provision of this Warranty is held invalid or unenforceable by a court of competent jurisdiction, such holding will not affect the validity or enforceability of any other provision.

Fluke Corporation  
P.O. Box 9090  
Everett, WA 98206-9090  
U.S.A.

Fluke Europe B.V.  
P.O. Box 1186  
5602 BD Eindhoven  
The Netherlands

# Table of Contents

Chapter	Title	Page
<b>1</b>	<b>Introduction and Specifications.....</b>	<b>1-1</b>
	Introduction .....	1-1
	Specifications .....	1-1
<b>2</b>	<b>Theory of Operation.....</b>	<b>2-1</b>
	Introduction .....	2-1
	Analog Measurement IC (U1) .....	2-1
	Microcomputer IC (U2).....	2-3
	Automatic Selection Input Resistance.....	2-3
<b>3</b>	<b>Maintenance .....</b>	<b>3-1</b>
	Introduction .....	3-1
	Disassembly and Reassembly.....	3-1
	Cleaning.....	3-6
	Performance Tests .....	3-6
	Calibration Adjustments for Models 12B and 18.....	3-9
	Calibration Adjustments for Models 7-300 and 7-600.....	3-10
<b>4</b>	<b>Parts and Schematics.....</b>	<b>4-1</b>
	Introduction .....	4-1
	How to Obtain Parts .....	4-1
	Manual Status Information.....	4-2
	Newer Instruments.....	4-2
	Parts Lists, Drawings, and Schematics.....	4-2



# ***List of Tables***

<b>Table</b>	<b>Title</b>	<b>Page</b>
1-1.	Specifications.....	1-2
2-1.	Electrical Components on Main PCA.....	2-2
2-2.	U1 Pinout Table.....	2-4
3-1.	Required Equipment .....	3-6
3-2.	Performance Tests for Models 7-300 and 7-600 .....	3-7
3-3.	Performance Tests for Models 12B and 18 .....	3-8
4-1.	Manual Status Information .....	4-2
4-2.	Models 12B, 18, and 18/AL Final Assembly .....	4-3
4-3.	Models 7-300 and 7-600 Final Assembly.....	4-5
4-4.	A1 Main PCA .....	4-7



# ***List of Figures***

<b>Figure</b>	<b>Title</b>	<b>Page</b>
2-1.	Typical Automatic Selection Input Resistance with DC Volts Function Selected	2-3
3-1.	Models 12B and 18 Disassembled Unit.....	3-3
3-2.	Models 7-300 and 7-600 Disassembled Unit.....	3-4
3-3.	Removing and Reinserting the Printed Circuit Assembly .....	3-5
3-4.	Calibration Adjustment.....	3-10
4-1.	Models 12B and 18 Final Assembly.....	4-4
4-2.	Models 7-300 and 7-600 Final Assembly.....	4-6
4-3.	Models 12B, 18, 7-300, and 7-600 Main PCA Components .....	4-9
4-4.	Model 12B Schematic.....	4-10
4-5.	Model 18 Schematic .....	4-12
4-6.	Model 7-300 Schematic .....	4-14
4-7.	Model 7-600 Schematic .....	4-16













## MULTIMETER SAFETY

The Fluke 7-300, 7-600, 12B, and 18 Meters have been designed and tested according to IEC Publication 1010, Safety Requirements for Electronic Measuring Apparatus. This manual contains information and warnings that must be followed to ensure safe operation and keep the meter in safe condition. Use of this equipment in a manner not specified herein may impair the protection provided by the equipment.

These multimeters comply with part 15 of the FCC Rules. Operation is subject to the following two conditions: (1) these meters may not cause harmful interference, and (2) these meters must accept any interference received, including interference that may cause undesired operation.

Some common international electrical symbols are shown below:

	AC: ALTERNATING CURRENT		DANGEROUS VOLTAGE
	DC: DIRECT CURRENT		EARTH GROUND
	EITHER AC OR DC CURRENT		SEE EXPLANATION IN MANUAL
	FUSE		DOUBLE INSULATION FOR PROTECTION AGAINST ELECTRIC SHOCK

Before using the meter, read the following safety information carefully. In this manual, "Warning" is reserved for conditions and actions that pose hazard(s) to the user; "Caution" is reserved for conditions and actions that may damage your meter.

- Avoid working alone.
- Follow all safety procedures for equipment being tested.
- Inspect the test leads for damaged insulation or exposed metal. Check test lead continuity. Damaged leads should be replaced.
- Be sure the meter is in good operating condition.
- Select the proper function for your measurement.
- To avoid electrical shock, use caution when working above 60V dc or 30V ac rms.
- Disconnect the live test lead before disconnecting the common test lead.
- Disconnect the power and discharge high-voltage capacitors before testing in resistance and diodes or continuity.
- When making a current measurement, turn the circuit power off before connecting the meter in the circuit.
- Check meter fuses before measuring transformer secondary or motor winding current. An open fuse may allow high voltage build-up, which is potentially hazardous.
- Use clamp-on probes when measuring circuits exceeding 10 amps.
- When servicing the meter, use only the replacement parts specified.
- Do not allow the meter to be used if it is damaged or if its safety features are impaired.

# **Chapter 1**

## ***Introduction and Specifications***

### ***Introduction***

#### **Warning**

**Service procedures described herein should be performed by qualified personnel only. To avoid electric shock, perform only those service procedures described in this manual.**

The 12B, 18, 7 Series Service Manual provides the information necessary to service the Fluke Model 12B, Model 18, and Models 7-300 and 7-600 meters. This manual provides the following information:

- Specifications (Chapter 1)
- Basic theory of operation (Chapter 2)
- Disassembly and reassembly (Chapter 3)
- Performance tests (Chapter 3)
- Calibration (Chapter 3)
- Illustrated parts lists and schematic diagrams (Chapter 4)

Refer to the users instruction sheet for operating instructions.

### ***Specifications***

Specifications are in Table 1-1. Accuracy is specified for a period of one year after calibration, at 18°C to 28°C (64°F to 82°F) with relative humidity to 90%. AC conversions are ac-coupled, average responding, and calibrated to the rms value of a sine wave input.

Accuracy specifications are given as follows:

$$\pm([\% \text{ of reading}] + [\text{number of least significant digits}])$$

**Table 1-1. Specifications**

<b>Maximum Voltage Between any Terminal and Earth Ground (excludes 10% tolerance)</b>	600V ac rms or dc
<b>Display</b>	3-3/4-digits, 4000 counts, updates 4/sec
<b>Operating Temperature</b>	-10°C to 50°C
<b>Storage Temperature</b>	-30°C to 60°C indefinitely (to -40°C for 100 hrs)
<b>Temperature Coefficient</b>	0.1 x (specified accuracy)/°C (<18°C or >28°C)
<b>Relative Humidity</b>	0% to 90% (-10°C to 35°C) 0% to 70% (35°C to 50°C)
<b>Battery Type</b>	9V, NEDA 1604 or IEC 6F22
<b>Battery Life</b>	650 continuous hours with alkaline; 600 hours for Model 7 450 continuous hours with carbon-zinc; 400 hours for Model 7
<b>Shock, Vibration</b>	1 meter shock. Per MIL-T-28800D for a Class 3 Instrument
<b>Size (HxWxL)</b>	1.35 in x 2.75 in x 5.55 in (3.46 cm x 7.05 cm x 14.23 cm)
<b>Weight</b>	10 oz (286g)
<b>EMI Regulations</b>	Complies with FCC Part 15, Class B, and VDE 0871B.
<b>Safety</b>	Designed to Protection Class II requirement of UL1244, ANSI/ISA-S82.01 - 1988, CSA C22.2 No 231, and VDE 0411, and IEC 1010-1 overvoltage category III (CAT III), 600V.

Trademark of TÜV Product Services.  
IEC 348 certification; designed to  
comply with EN 61010-1: 1993.



The logo consists of a rounded rectangle containing the text 'TÜV' in a large font, 'PRODUCT SERVICE' in a smaller font below it, and a stylized 'GS' logo to the right. Below the 'GS' logo is the text 'geprüfte Sicherheit'.



The CE mark consists of the letters 'C' and 'E' in a stylized, bold font.

**Table 1-1. Specifications (continued)**





Function	Range	Resolution	Accuracy (50 to 400 Hz)		
			7-300	7-600	12B/18
$V_{\sim}$	4000 mV <sup>1</sup>	1 mV	NA	NA	±(1.9%+3)
	4.000V	0.001V	NS <sup>2</sup>	NS <sup>2</sup>	±(1.9%+3)
	40.00V	0.01V	±(2.9%+3)	±(2.9%+3)	±(1.9%+3)
	300.0V	0.1V	±(2.9%+3)	NA	NA
	400.0V	0.1V	NA	±(2.9%+3)	±(1.9%+3)
	600.0V	1V	NA	±(2.9%+3)	±(1.9%+3)
$V_{\text{---}}$	4000 mV <sup>1</sup>	1 mV	NA	NA	±(0.9%+2)
	4.000V	0.001V	NS <sup>2</sup>	NS <sup>2</sup>	±(0.9%+2)
	40.00V	0.01V	±(1.5%+1)	±(1.5%+1)	±(0.9%+1)
	300.0V	0.1V	±(1.5%+1)	NA	NA
	400.0V	0.1V	NA	±(1.5%+1)	±(0.9%+1)
	600V	1V	NA	±(1.5%+1)	±(0.9%+1)
$\Omega$	400.0 $\Omega$	0.1 $\Omega$	±(1.5%+2)	±(1.5%+2)	±(0.9%+2)
	4.000 k $\Omega$	0.001 k $\Omega$	NA	NA	±(0.9%+1)
	40.00 k $\Omega$	0.01 k $\Omega$	NA	NA	±(0.9%+1)
	400.0 k $\Omega$	0.1 k $\Omega$	NA	NA	±(0.9%+1)
	4.000 M $\Omega$	0.001 M $\Omega$	NA	NA	±(0.9%+1)
	40.00 M $\Omega$	0.01 M $\Omega$	NA	NA	±(1.5%+3)
$\text{---}(\text{---})$	1.000 $\mu$ F	0.001 $\mu$ F	NA	NA	±(1.9%+2)
	10.00 $\mu$ F	0.01 $\mu$ F	NA	NA	±(1.9%+2)
	100.0 $\mu$ F	0.1 $\mu$ F	NA	NA	±(1.9%+2)
	1000 $\mu$ F	1 $\mu$ F	NA	NA	±(1.9%+2)
	10000 $\mu$ F	10 $\mu$ F	NA	NA	±(10%+90) typical
$\text{---}\text{---}(\text{---})$ <sup>3</sup>	2.000V	0.001V	NA	NA	±(0.9%+2)

1. The 4000 mV range can be entered only in the manual range mode. Use the 4000 mV range with accessories. The 4000 mV range is not available on the Model 7.

2. Not specified for the Model 7.

3. The beeper is guaranteed to come on at <25 $\Omega$  and turn off at >250 $\Omega$ . The meter detects opens or shorts of 250  $\mu$ s or longer. These values are not specified for the Model 7.

Table 1-1. Specifications (continued)

Function	Overload Protection <sup>1</sup>	Input Impedance (Nominal)	Common Mode Rejection Ratio (1 kΩ Unbalanced) <sup>2</sup>		Normal Mode Rejection <sup>2</sup>
	600V rms or dc	>5 MΩ <100pF <sup>2</sup> Automatic Selection and LoZ = >2 kΩ <200pF (ac coupled) <sup>3</sup>	>60 dB at dc 50 or 60 Hz		
	600V rms or dc	>10MΩ <100pF <sup>2</sup> Automatic Selection and LoZ = >2 kΩ <200pF <sup>3</sup>	>100 dB at dc, 50 or 60 Hz		>50 dB at 50 Hz or 60 Hz
		<b>Open Circuit Test Voltage</b>	<b>Full Scale Voltage To 4.0 MΩ 40 MΩ</b>		<b>Short Circuit Current</b>
	600V rms or dc	<1.5V dc	<450 mV dc	<1.5V dc	<500 μA
	600V rms or dc	2.4-3.0V dc	2.400V dc		0.95 mA (typical)
<p>1. 3 x 10<sup>6</sup> V Hz maximum.</p> <p>2. Does not apply to Model 7.</p> <p>3. ~2 kΩ input impedance up to 50V. Impedance increases with input voltage to &gt;300 kΩ at 600V.</p>					
<p><b>MIN MAX Recording Accuracy and Response Time (Models 12B and 18)</b></p> <p>Specified accuracy of the measurement function ±12 digits for changes &gt;200 ms in duration (±40 digits in ac). Typical 100 ms response to 80%.</p> <p><b>MIN MAX Recording with Elapsed Time (Models 12B and 18)</b></p> <p>Elapsed Time: 0 to 100 hours (99.59)</p> <p>Resolution: 1 minute</p> <p>Accuracy: 0.3% typical</p> <p><b>Continuity Capture™ (Model 12B)</b> <b>(Open/Short Capture Model 18)</b></p> <p>Detects opens or shorts of 250 μs or longer.</p>					

# **Chapter 2**

## **Theory of Operation**

### **Introduction**

Chapter 2 provides a basic theory of operation for the Models 7, 12B, and 18 Meters. Electrical components on the printed circuit assembly (A1 Main PCA) are listed in Table 2-1. Refer to Figure 4-3 for the location of these components and Figures 4-4 through 4-7 for the schematic diagrams.

The analog/digital IC (U1) performs the electrical measurement functions. See Table 2-2 for pin names and descriptions. The microcomputer (U2) controls U1, the LCD (U3), and the user interface. Discrete components support U1 and U2, provide reference standards for measurements, and provide input overload protection.

### **Analog Measurement IC (U1)**

U1 performs the following analog functions: a/d converter, ac to dc converter, Automatic Selection circuitry, active filter, passive filter, power supply, range configuration circuitry, signal routing circuitry, beeper driver, digital control circuitry, and digital U2 interface circuitry.

The a/d converter is a patented dual-rate, dual-slope converter. The dual-rate conversion allows for MIN MAX (Models 12B and 18 only) and fast autoranging functions. The ac to dc converter is full-wave rectified and average-responding. The active and passive filters are two-pole and one-pole low-pass filters (respectively) that are used for signal filtering prior to a/d conversion. The internal power supply generates a ground voltage nominally +3V relative to VSS. Range configuration circuitry connects the Z1 resistor network as needed for different ranges. Routing circuitry connects the various signal conditioning circuits as needed. The a/d converter and a counter are controlled by a state machine.

**Table 2-1. Electrical Components on Main PCA**

<b>Circuit and Function</b>	<b>Component Designator(s)</b>
Analog Measurement IC	U1
Microcomputer IC	U2
Input Divider and Ohms Reference Resistor Network	Z1
Input Divider AC Coupling Capacitor	C14
J2 Input Receptacle Voltage Sense Resistor	R17
J1 Input Receptacle Voltage Sense Resistor	R14
Reference Voltage for Volts Measurements	VR1, R4, R5, R6, R26
A/D Converter Integrate Capacitor	C2
A/D Converter Autozero Capacitor	C1
A/D Converter Gain Resistors	R1, R3, R15
Active Filter Components	R7, R8, C5, C6
Passive Filter Components	R9, C7
AC to DC Converter Gain Resistors	R11, R12, R13
AC to DC Converter AC Coupling Capacitor	C8
Bias Current Setting Resistor	R2
DGND-VSS Voltage Setting Resistors	R10, R24
Power Supply Bypass Capacitors	C3, C15
Reverse Battery Protection	CR1
System Clock	Y1
Automatic Selection Input Current Limiters	R16, R18, R29
Automatic Selection Input Positive Temp. Coef. Thermistor	RT1
Automatic Selection Input Voltage Clamp Circuit	Q1, Q2, CR2, R28
Automatic Selection Input Fusible Resistor	R19
Microcomputer Reset Circuit	R23, R25, C10, C13, CR3
On/Off and Automatic Selection Select Slide Switch	S1
Beeper	LS1
Beeper Current Limiter	R22
Slide Switch Protection	E1
Switch Sense Bypass Capacitor	C9
Input Divider Bypass Capacitor	C16
Zero Ohm Jumpers	R20, R21, R27

Finally, digital circuitry interfaces with U2 via a parallel address and bidirectional data bus.

Voltage is measured using a ratio comparison of the unknown voltage to the reference voltage (REFI pin). Resistance is calculated using a ratio comparison of the voltage across the unknown resistor to the voltage across a precision reference resistor, with the same current in both. Capacitance is measured by determining the amount of charge added for a given dc voltage change.

### Microcomputer IC (U2)

U2 writes range settings and a/d converter information to U1. U2 reads a/d converter results and status information. This includes the low battery check, slide-switch position, continuity check, and Automatic Selection data. The microcomputer performs math operations on the raw data from U1 and configures it for the LCD. U2 also reads push-button inputs. Finally, the 2.1 MHz clock signal at U2 is divided down to 131 kHz and sent to U1 (CLK pin) for the counter.

### Automatic Selection Input Resistance

As shown in Figure 2-1, the input resistance for the Automatic Selection function is non-linear. The data in the graph are for the volts dc function (any range) and are the steady state values obtained after the PTC thermistor (RT1) has stabilized. The data also apply for the volts ac function.

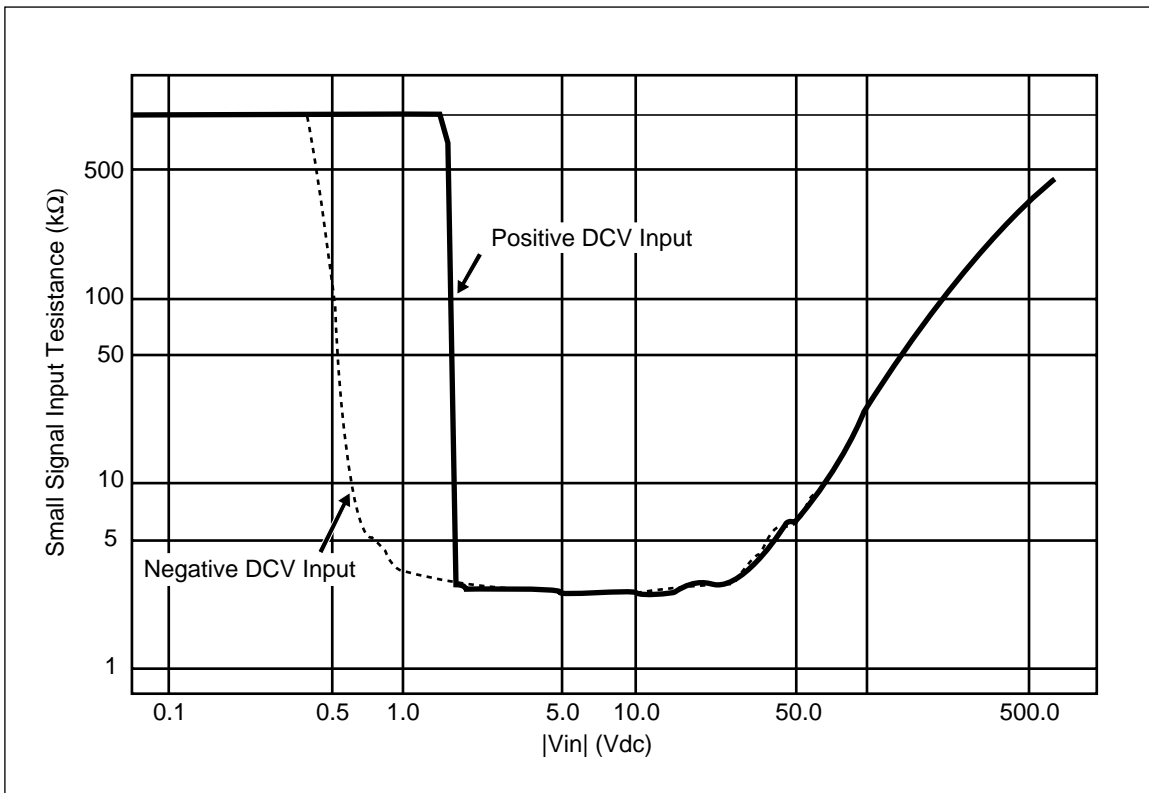

Figure 2-1. Typical Automatic Selection Input Resistance with DC Volts Function Selected

as01f.eps



Table 2-2. U1 Pinout Table

Pin No.	Pin Name	Description
1	READ (L)	When low (VSS), data from addressed register can be read
2	ADR5	Most significant address bus line
3	ADR4	Bit 4 of parallel address bus
4	ADR3	Bit 3 of parallel address bus
5	ADR2	Bit 2 of parallel address bus
6	ADR1	Bit 1 of parallel address bus
7	ADR0	Least significant address bus line
8	VSS	Negative power supply voltage (-3V relative to DGND)
9	VDD	Positive power supply voltage for analog only (Vbat-3V=VDD-DGND)
10	K0	1st a/d gain resistor pin, generally for de-integrate
11	K1	2nd a/d gain resistor pin, generally for integrate
12	K2	3rd a/d gain resistor pin, for autozero
13	AZ	A/D converter pin for autozero capacitor
14	INT	A/D converter pin for integrator capacitor
15	REFI	1.00V reference voltage for de-integrate signal in volts
16	BIAS	Pin for analog bias current generator reference resistor
17	REFH	Connects 1.235V reference voltage to on-chip circuits
18	BGND	Not used
19	AFO	Active filter high output pin (2-pole, low-pass filter)
20	FAO	Internal active filter node
21	FAI	Internal active filter node
22	AFI	Active filter high input pin
23	VSS	Negative power supply voltage (-3V relative to DGND)
24	PFO	Passive filter low output pin (1-pole, low-pass filter)
25	AVAOM	Absolute value amp (full wave rectified) negative output pin
26	AVAOP	Absolute value amp (full wave rectified) positive output pin
27	AVAM	Absolute value amp inverting input (summing node)
28	ACBO	AC buffer output
29	VSET	Voltage divider sense for power supply
30	PSTEST	Pin to disable on-chip power supply for U1 testing
31	DGND	Ground power supply pin connected to common (digital ground)
32	AGND	Common input sense line. No current flow (analog ground).
33	CLAMP	Op amp output voltage for Q2 clamp transistor base drive
34	AMPS	Shunt resistor sense pin. Unused in Fluke Model 18.
35	ISRC	Current source pin for continuity, ohms, and capacitance
36	SWS	Slide-switch position sense pin. Internal pull down.
37	OHMS	Ohms sense resistor input pin. Sense voltage at J2.
38	VSS	Negative power supply voltage (-3V relative to DGND)
39	ACV	AC volts input pin from 10 M $\Omega$ resistor

**Table 2-2 U1 Pinout Table (continued)**

<b>Pin No.</b>	<b>Pin Name</b>	<b>Description</b>
40	APV0	DC volts input pin from 10 M $\Omega$ resistor
41	DIVLO	Input divider (Z1) common (low) pin
42	APV1	10-to-1 voltage divider and 1 M $\Omega$ reference resistor input
43	APV2	100-to-1 voltage divider and 100 k $\Omega$ reference resistor input
44	APV3	1000-to-1 voltage divider and 10 k $\Omega$ reference resistor input
45	APV4	10,000-to-1 voltage divider and 1 k $\Omega$ reference resistor input
46	GND	Ground power supply pin connected to common (digital ground)
47	DATA3	Most significant bidirectional data bus line
48	DATA2	Bit 2 of parallel data bus
49	DATA1	Bit 1 of parallel data bus
50	DATA0	Least significant bidirectional data bus line
51	N/C	No connection
52	BEEPER (L)	One of two beeper drive lines. Voltage swings VDD to VSS.
53	VSS	Negative power supply line (-3V relative to DGNG)
54	VSS	Negative power supply line (-3V relative to DGNG)
55	CLK	System clock line from U2. 131,072 Hz.
56	BCLK	Beeper frequency (2.3 kHz) clock line from U2
57	TESTCLK	Test clock pin for U1 testing
58	BEEPER	One of two beeper drive lines. Voltage swings VDD to VSS.
59	N/C	No connection
60	WRITE (L)	When driven low (VSS), data is written to addressed register





# static awareness



## A Message From Fluke Corporation

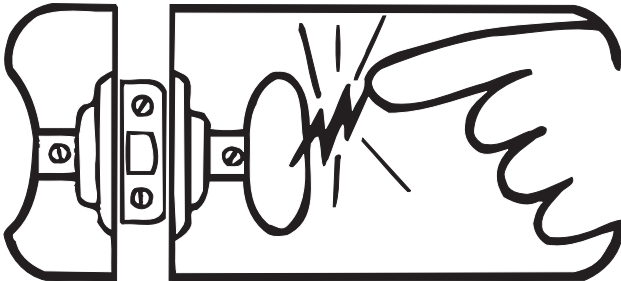

Some semiconductors and custom IC's can be damaged by electrostatic discharge during handling. This notice explains how you can minimize the chances of destroying such devices by:

1. Knowing that there is a problem.
2. Learning the guidelines for handling them.
3. Using the procedures, packaging, and bench techniques that are recommended.

The following practices should be followed to minimize damage to S.S. (static sensitive) devices.

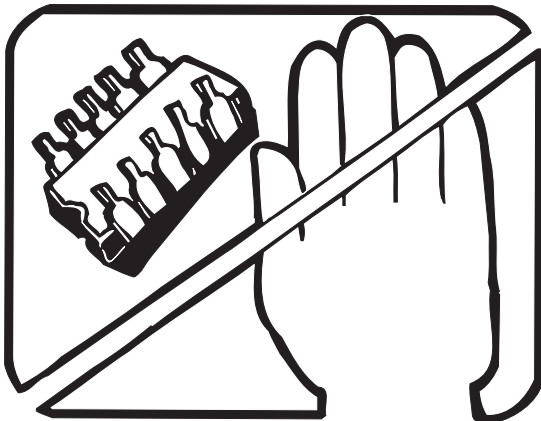

1. MINIMIZE HANDLING

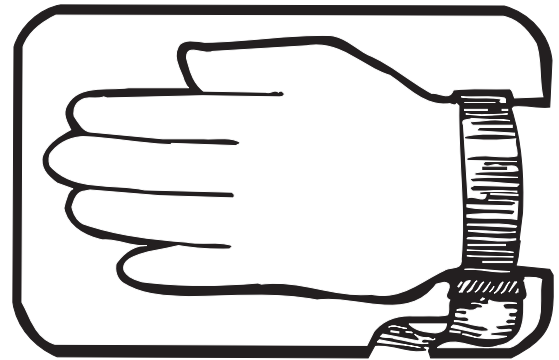

3. DISCHARGE PERSONAL STATIC BEFORE HANDLING DEVICES. USE A HIGH RESISTANCE GROUNDING WRIST STRAP.

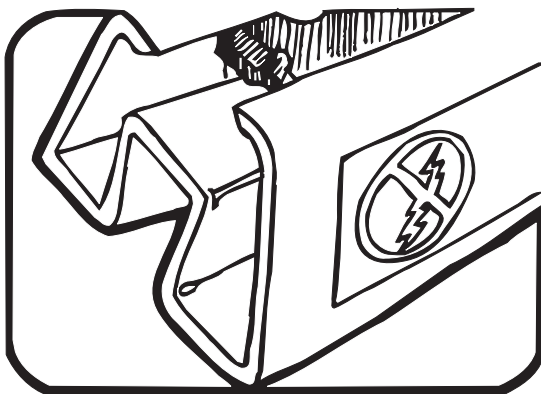

2. KEEP PARTS IN ORIGINAL CONTAINERS UNTIL READY FOR USE.

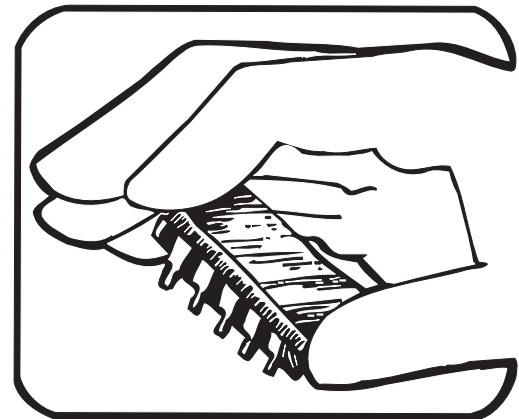

4. HANDLE S.S. DEVICES BY THE BODY.

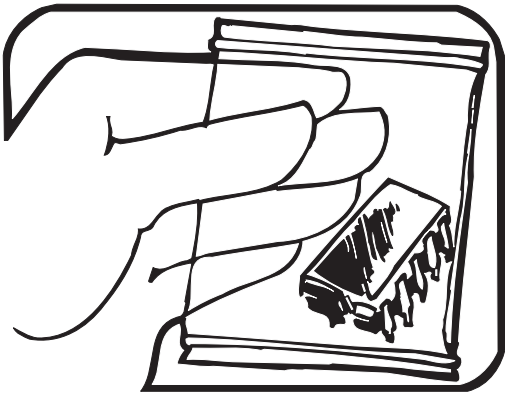

5. USE STATIC SHIELDING CONTAINERS FOR HANDLING AND TRANSPORT.

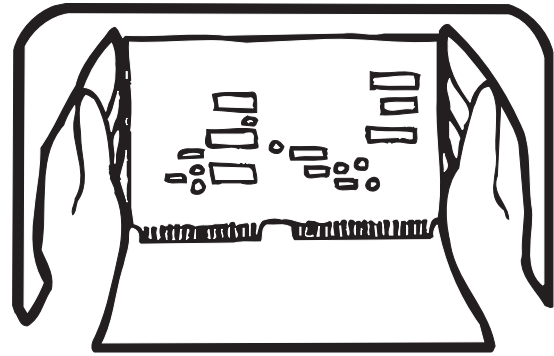

8. WHEN REMOVING PLUG-IN ASSEMBLIES HANDLE ONLY BY NON-CONDUCTIVE EDGES AND NEVER TOUCH OPEN EDGE CONNECTOR EXCEPT AT STATIC-FREE WORK STATION. PLACING SHORTING STRIPS ON EDGE CONNECTOR HELPS PROTECT INSTALLED S.S. DEVICES.

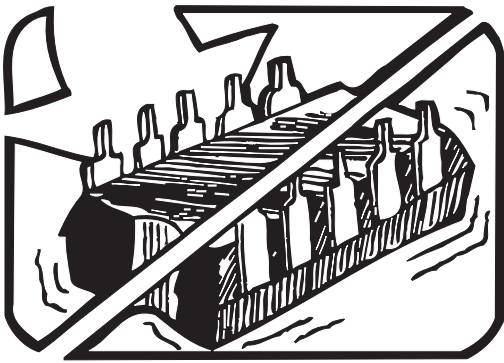

6. DO NOT SLIDE S.S. DEVICES OVER ANY SURFACE.

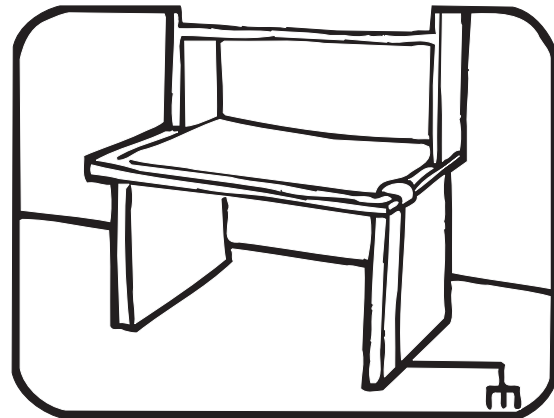

9. HANDLE S.S. DEVICES ONLY AT A STATIC-FREE WORK STATION.

10. ONLY ANTI-STATIC TYPE SOLDER-SUCKERS SHOULD BE USED.

11. ONLY GROUNDED-TIP SOLDERING IRONS SHOULD BE USED.

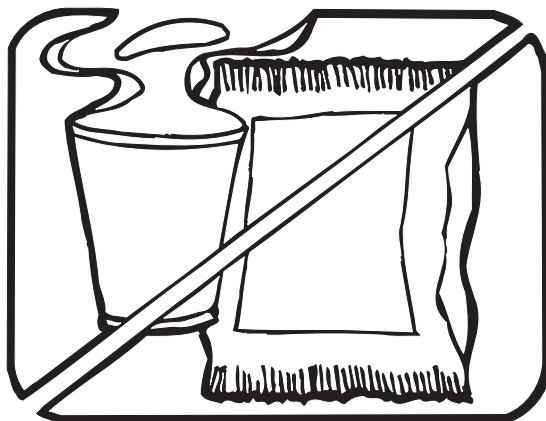

7. AVOID PLASTIC, VINYL AND STYROFOAM® IN WORK AREA.

PORTIONS REPRINTED  
WITH PERMISSION FROM TEKTRONIX INC.  
AND GERNER DYNAMICS, POMONA DIV.

# **Chapter 3**

## **Maintenance**

### **Introduction**

Chapter 3 covers the following:

- Disassembly and reassembly
- Cleaning
- Performance tests
- Calibration

### **Disassembly and Reassembly**

#### **Warning**

To avoid electrical shock, remove test leads and any input signals before opening the case.

#### **Caution**

To avoid contamination from the fingers, handle the pca by the edges or wear gloves. PCA contamination can cause failures in humid environments. This meter contains components that can be damaged by static discharge. To avoid damaging these components when servicing the meter, take precautions indicated on the "Static Awareness" at the beginning of Chapter 3.

Referring to Figures 3-1 and 3-2 as necessary, disassemble the meter as follows. A Phillips-head screwdriver and small flat-blade screwdriver are required.

1. Remove the test leads and set the slide switch or rotary knob to OFF.
2. Remove the Phillips-head screws (H1-4) from the case bottom (MP8).
3. Separate the case top (MP2) from the case bottom.
4. **TO REPLACE THE BATTERY:** Lift the battery from the case bottom and insert a new 9V battery (NEDA 1604, 6F22, or 006P). Be sure the positive and negative battery posts are oriented correctly.
5. **TO REMOVE THE PCA (A1):** Insert a small, flat-blade screwdriver between the edge of the case top and the pca where shown in Figure 3-3. Gently unsnap a side of the case top from the pca. Repeat on the other side of the pca. Unsnap the case from the top of the pca last.
6. **LIFT THE PCA FROM THE CASE TOP BY ITS EDGES.** If the elastomeric contact strips (J3, J4)\* for the switch assembly (S2)\* and LCD (U3) are stuck to the pca, remove them without touching the conductive edges.

*TO REINSERT THE PCA: Important: First make sure that the slide-switch actuator (MP5), the slide switch (S1), and the rotary knob (for the 12B and 18) are in the OFF position.* Place the pca over the four screw posts in the case top, then press gently on the center of the pca while using the small flat-edge screwdriver to shoehorn the pca under the snap on a side of the case top. Repeat on the other side and the top.

7. **TO REMOVE THE SWITCH SUPPORT (MP6):** Use a small, flat-blade screwdriver to gently unsnap the sides and top of the switch support from the snaps shown in Figure 3-3.
8. The LCD, switch assembly, slide-switch actuator, and elastomeric contact strips (J3, J4) for the LCD and switch assembly are accessible and can be replaced as needed. Do not allow the LCD to get wet. Before installing a new LCD, make sure that all connector contact points are clean.

### **Caution**

**Do not touch the conductive edges of the elastomeric strips or the contacts on the switch assembly. If they are contaminated, clean them with isopropyl alcohol.**

9. Reassembling the meter is the reverse of disassembling it. After the meter is reassembled, execute the PERFORMANCE TESTS to confirm that the meter is working properly.

---

\* J4 and S2 are not present in Models 7-300 and 7-600.

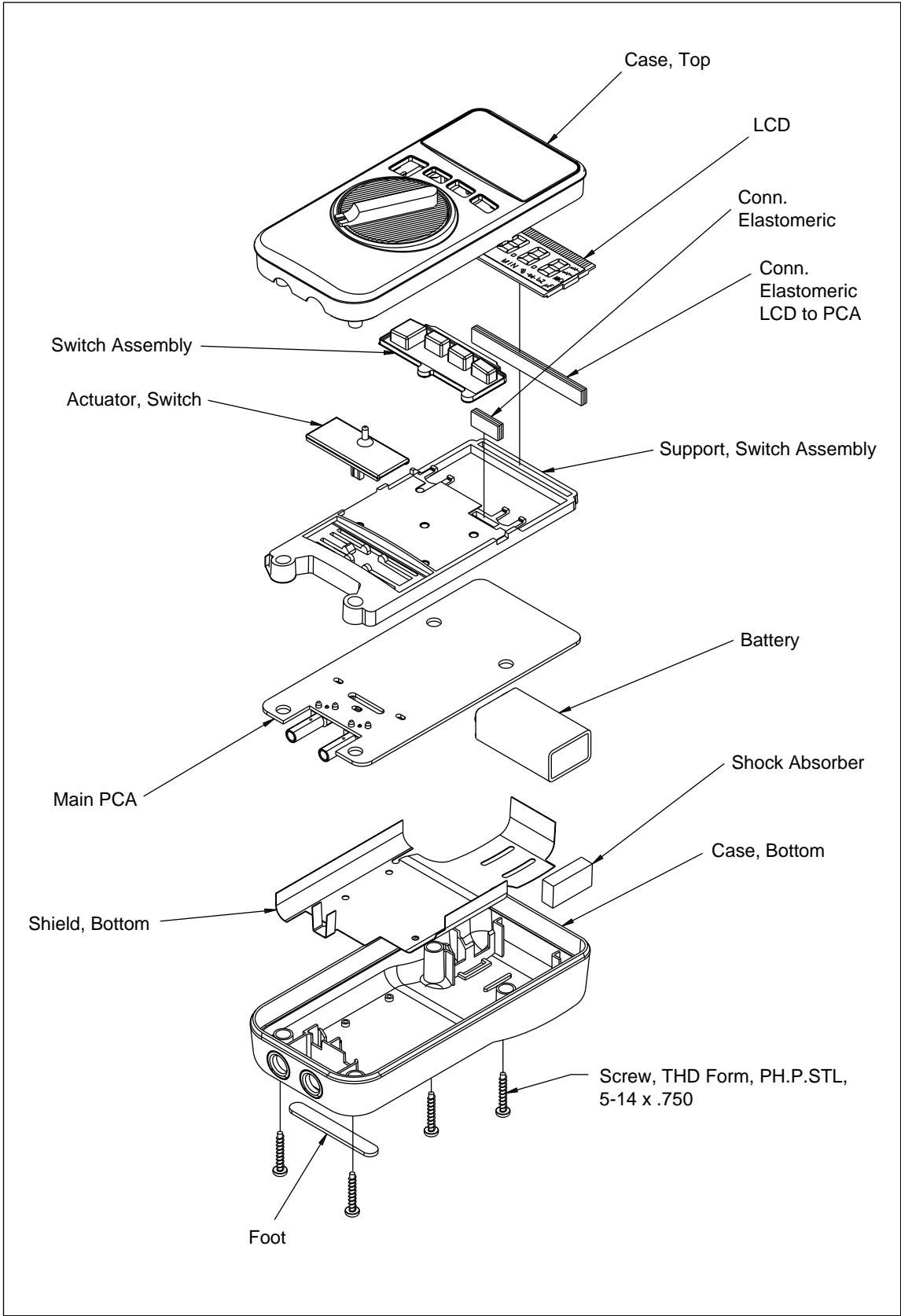

Figure 3-1. Models 12B and 18 Disassembled Unit

as07f.eps



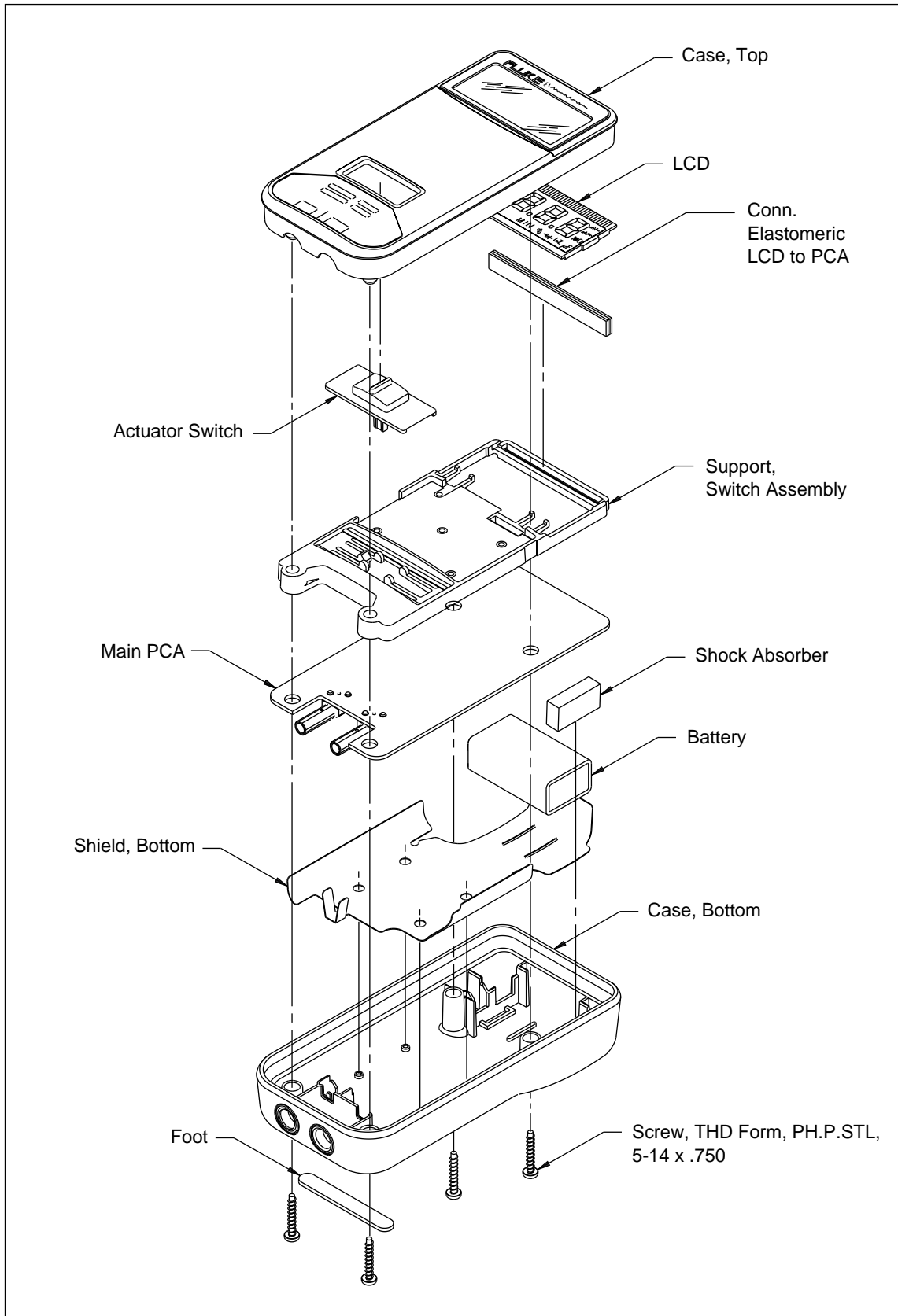
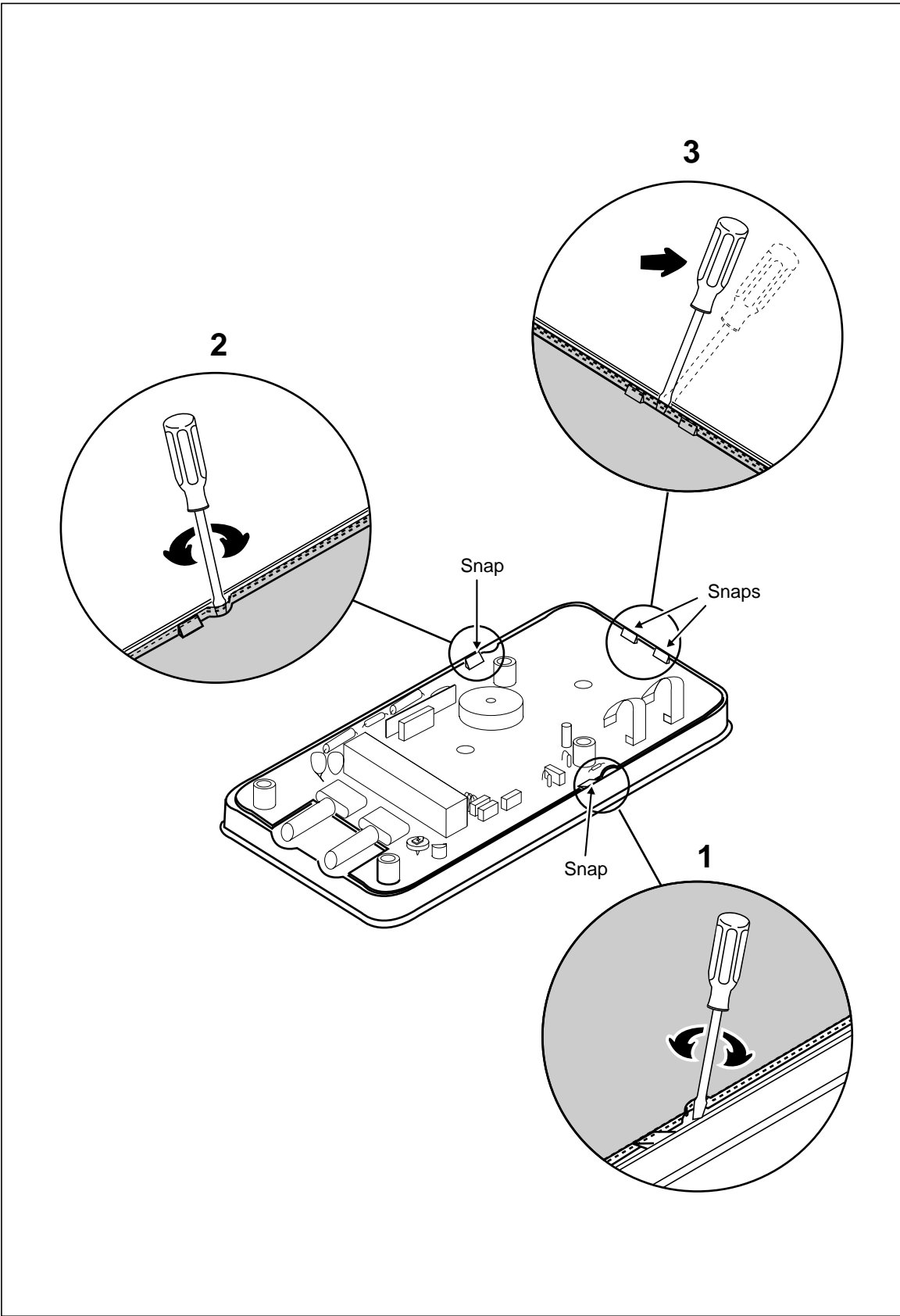

Figure 3-2. Models 7-300 and 7-600 Disassembled Unit

as10f.eps



as04f.eps

Figure 3-3. Removing and Reinserting the Printed Circuit Assembly

## Cleaning

### Caution

**To avoid damaging the meter, do not use aromatic hydrocarbons or chlorinated solvents for cleaning. These solutions will react with the plastics used in the instruments. Do not get the LCD wet.**

To clean the case, wipe it with a cloth lightly dampened with water and a mild detergent.

Wash the pca with isopropyl alcohol or hot deionized water and a soft brush. Do not use detergent of any kind for cleaning the pca. The pca must be completely dry before the meter is reassembled. Dry the pca with clean dry air at low pressure (<20 psi); then bake it at 50°C for 2 hours.

## Performance Tests

### Warning

**To avoid electric shock, do not execute the performance tests procedures unless the meter is fully assembled.**

Use the PERFORMANCE TESTS to confirm that the meter is working properly. If the meter fails any of these tests, it needs calibration (see CALIBRATION) or repair. The equipment required is specified in Table 3-1.

1. Connect the calibrator to the [+] and COM jacks on the meter.
2. Referring to Table 3-2 for the Fluke 7-300 or 7-600, or Table 3-3 for the Fluke 12B or 18, put the meter in the function and range shown for Test 1.
3. Apply the input from the appropriate source. The reading on the display should be within the MINIMUM and MAXIMUM values shown in Table 3-2 or 3-3.
4. Test the remaining functions and ranges.

**Table 3-1. Required Equipment**

Equipment	Minimum Specifications	Recommended Models
DMM Calibrator	DC Voltage: 0-600V Accuracy: $\pm 0.25\%$ AC Voltage: 0-600V Accuracy: $\pm 0.5\%$ Frequency: 50-400 Hz	Fluke Models 5700A, 5500A, 5100B, or equivalent
Decade Resistor	Resistance: 1.0-40 M $\Omega$ Accuracy: $\pm 0.25\%$	General Resistance RDS-77B and 41B or Fluke 5500A
Decade Capacitor	Capacitance: 0-1.000 $\mu\text{F}$ Accuracy: $\pm 0.5\%$	GenRad 1412-BC or Fluke 5500A

**Table 3-2. Performance Tests for Models 7-300 and 7-600**

Test No.	Applicable Model(s) <sup>1</sup>	Meter Range	Input To Meter	Display Minimum	Display Maximum
1	7-300/7-600	40.00V ac	4.40V, 50 Hz	4.24	4.56
2	7-300/7-600	40.00V ac	35V, 50 Hz	33.95	36.05
3	7-300/7-600	40.00V ac	35V, 400 Hz	33.95	36.05
4	7-300/7-600	400.0V ac (300.0V ac for 7-300)	100V, 50 Hz	96.8	103.2
5	7-300/7-600	400.0V ac (300.0V ac for 7-300)	150V, 400 Hz	145.4	154.6
6	7-300	300V ac	300V, 50 Hz	291	309
7	7-600	400.0V ac	350V, 80 Hz	339.5	360.5
8	7-600	600V ac	600V, 400 Hz	580	620
9	7-300/7-600	40.00V dc	4.40V dc	4.32	4.48
10	7-300/7-600	40.00V dc	-35V dc	-35.54	-34.46
11	7-300/7-600	400.0V dc	+100V dc	+98.4	+101.6
12	7-300/7-600	400.0V dc (300.0V dc for 7-300)	-150V dc	-152.3	-147.7
13	7-300/7-600	400.0V dc (300.0V dc for 7-300)	300V dc	295.4	304.6
14	7-600	600V dc	-600V dc	-610	-590
15 <sup>2</sup>	7-300/7-600	400.0Ω	0.0Ω	0.0	0.2
16 <sup>2</sup>	7-300/7-600	400.0Ω	1.0Ω	0.8	1.2
17 <sup>3</sup>	7-300/7-600	400.0Ω	350.0Ω	344.5	355.5
<ol style="list-style-type: none"> <li>1. To avoid overload/current limit condition on the calibrator when testing the Model 7, defeat the 50Ω divider on the calibrator and allow at least 3 seconds at each voltage interval above 40V.</li> <li>2. Model 7 beeper should be on.</li> <li>3. Model 7 beeper may be on or off.</li> </ol>					

Table 3-3. Performance Tests for Models 12B and 18

Test No.	Meter Range (Automatic Selection 12B Only)	Input To Meter	Switch Position	Display Minimum	Display Maximum
1	4.000V ac	0V	Center	0.000	0.003
2	4.000V ac, MIN MAX	0V	Center	0.000	0.040
3	4.000V ac	10 mV, 50 Hz	Center	0.007	0.013
4	4.000V ac	10 mV, 400 Hz	Right <sup>1</sup>	0.007	0.013
5	4.000V ac	3.5V, 50 Hz	Right <sup>1</sup>	3.430	3.570
6	4.000V ac	3.5V, 400 Hz	Center	3.430	3.570
7	40.00V ac	35V, 50 Hz	Center	34.30	35.70
8	40.00V ac	35V, 400 Hz	Right <sup>1</sup>	34.30	35.70
9 <sup>2</sup>	400.0V ac	350V, 80 Hz	Right <sup>1</sup>	343.0	357.0
10	600V ac	600V, 400 Hz	Center	586	614
11	4.000V dc, MIN MAX	0V	Center	-0.012	0.012
12	4.000V dc	0V	Right <sup>1</sup>	-0.002	0.002
13	40.00V dc	+20 mV dc	Right <sup>1</sup>	00.01	00.03
14	400.0V dc	-200 mV dc	Center	-000.3	-000.1
15	4.000V dc	+3.5V	Center	+3.466	+3.534
16	40.00V dc	-35V dc	Center	-35.33	-34.67
17	400.0V dc	+100V dc	Center	+99.0	+101.0
18	600V dc	-600V dc	Center	-606	-594
19	Continuity	+2V dc <sup>3</sup>	Right	1.980	2.020
20 <sup>3</sup>	Continuity, Automatic Selection	+3.43V dc <sup>3</sup>	Right	3.397 <sup>4</sup>	3.463 <sup>4</sup>
21 <sup>3</sup>	Continuity, Automatic Selection	-0.5V dc <sup>3</sup>	Right	-0.507 <sup>4</sup>	-0.493 <sup>4</sup>
22	400.0Ω	0.0Ω	Right	0.0	0.2
23	400.0Ω	1.0Ω	Right	0.8	1.2
24	400.0Ω	350.0Ω	Right	346.6	353.4
25	4.000 kΩ	1.0 kΩ	Right	0.990	1.010
26	40.00 kΩ	35 kΩ	Right	34.67	35.33
27	400.0 kΩ	100 kΩ	Right	99.0	101.0
28	4.000 MΩ	2.9 MΩ	Right	2.873	2.927
29	40.00 MΩ	35 MΩ	Right	34.44	35.56
30	Ω, Automatic Selection	1.96V dc	Right	1.940 <sup>4</sup>	1.980 <sup>4</sup>
31 <sup>5</sup>	1.000 μF	0.0 μF	Right	-0.001 μF	0.001 μF
32 <sup>5</sup>	1.000 μF	0.95 μF	Right	0.930 μF	0.970 μF

1. Center position for Model 18.
2. In the Automatic Selection mode, the UUT uses a low-impedance thermistor (~2.5k for circuit protection and load testing (referred to as low-Z input circuitry). When using the 5100B, 5500A, or 5700A to drive the UUT with high voltages, avoid an overload/current limit condition by gradually stepping the voltage up (waiting two seconds between each step) from 90.0V, 120.0V, 180.0V, and 350.0V at 80 Hz each step.
3. Calibrator 50Ω divider override.
4. The dc volts annunciator must be on. Test does not apply to Model 18.
5. Conducting performance tests of the 400Ω, 4 kΩ, 40 kΩ, and 1 μF ranges (tests no. 22, 23, 24, 25, 26, 31, and 32) verifies that the discrete and integrated circuitry needed to support the other capacitance ranges are working within specifications. Therefore, the tests indirectly verify that the meter will meet specification in the 10 μF, 100 μF, 1000 μF, and 10,000 μF ranges.

## Calibration Adjustments for Models 12B and 18

To ensure that the meter performs to specifications, make calibration adjustments annually using the following procedure:

1. Set the calibrator for 0V dc. Put the meter in the 4.000V dc range.
2. Connect the calibrator to the [+] and COM jacks on the Meter.
3. Apply an input of +4.000V dc  $\pm 0.25\%$

The meter display should read between 3.997-4.003V. If it does not, adjust R4 (see Figure 3-4) as described below.

To adjust R4, proceed as follows:

1. Remove any input signals to the meter.
2. Remove the four screws on the back and separate the case bottom and case top.

Notice that when you do so the battery remains in the case bottom and power to the meter is disconnected.

3. Observing correct polarity, connect a 9V battery to the battery contacts using easy hook jumpers or alligator clip leads (see Figure 3-4).

*Note*

*To avoid stretching or bending the battery contacts, connect leads to the base of the contacts as shown in Figure 3-4.*

4. Set the calibrator for 0V dc. Put the meter in the 4.000V dc range.
5. Connect the calibrator to the [+] and COM jacks on the meter.
6. Apply an input of +4.000V dc  $\pm 0.25\%$
7. Adjust R4 (see Figure 3-4) so that the meter display reads between 3.997 and 4.003V.

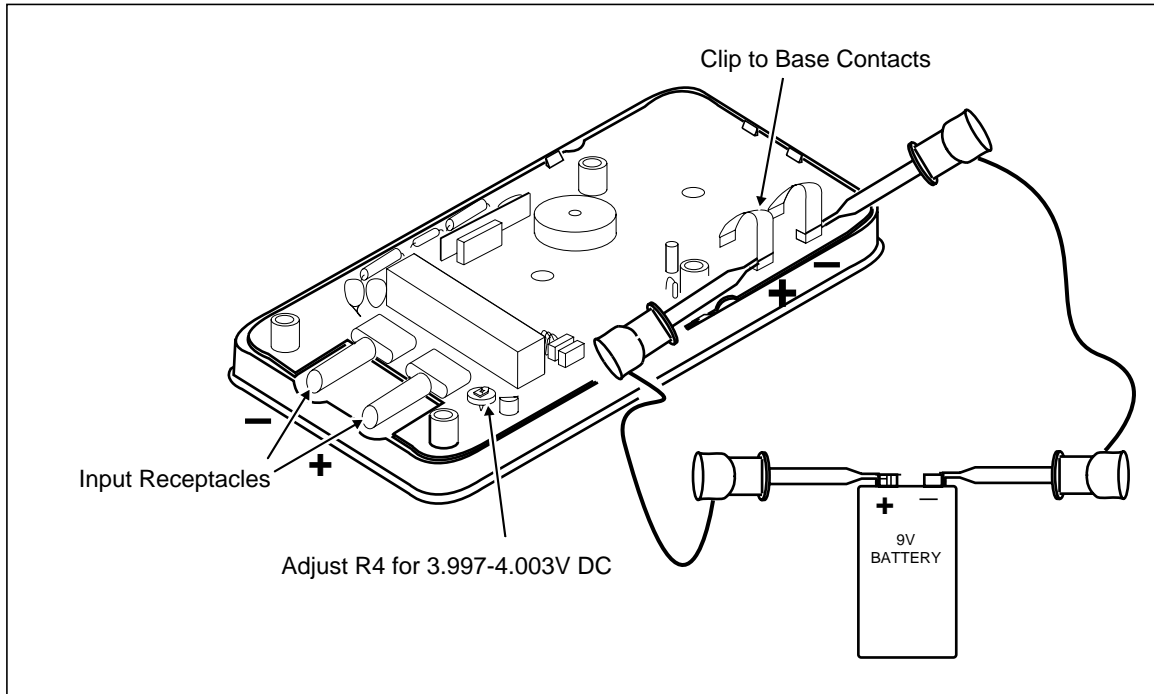

Figure 3-4. Calibration Adjustment

as05f.eps

### Calibration Adjustments for Models 7-300 and 7-600

To ensure that the meter performs to specifications, make calibration adjustments annually using the following procedure:

1. Set the calibrator for 0V dc. Switch the meter ON.
2. Connect the calibrator to the [+] and COM jacks on the meter. Defeat the 50 $\Omega$  divider on the calibrator (if any).
3. Apply an input of 3.500V dc  $\pm$ 0.25%. Wait at least 3 seconds.
4. Apply an input of 3.75V dc  $\pm$ 0.25%. Within 5 seconds the meter should display a reading between 3.747 and 3.753V dc. If it does not, adjust R4 as described below.

To adjust R4, proceed as follows:

1. Remove any input signal to the meter.
2. Remove the four screws on the back and separate the case bottom from the case top.  
Notice that when you do so, the battery remains in the case bottom and power to the meter is disconnected.
3. Observing the correct polarity, connect a known good 9V battery to the battery contacts using easy-hook jumpers or alligator clip leads. Refer to Figure 3-4.

#### Note

*To avoid stretching or bending the battery contacts, connect the leads to the base of the contacts, as shown in Figure 3-4.*

4. Set the calibrator for 0V dc. Turn the meter ON.

5. Connect the calibrator to the [+] and COM input jacks on the meter. Defeat the 50 $\Omega$  divider on the calibrator (if any).
6. Apply an input of 3.500V dc  $\pm 0.25\%$ . Wait at least 3 seconds.
7. Apply an input of 3.75V dc  $\pm 0.25\%$ . Wait 5 seconds.
8. Adjust R4 so that the meter displays a reading between 3.747 and 3.753V dc.
9. Remove the inputs to the meter, disconnect the battery, and reassemble the meter.





# **Chapter 4**

## **Parts and Schematics**

### ***Introduction***

This chapter contains an illustrated list of replaceable parts for the 7-300, 7-600, 12B, and 18 Meters. Parts are listed by assembly; alphabetized by reference designator. Each assembly is accompanied by an illustration showing the location of each part and its reference designator. The parts lists give the following information:

- Reference designator
- An indication if the part is subject to damage by static discharge
- Description
- Fluke stock number
- Total quantity
- Any special notes (i.e., factory-selected part)

### **Caution**

**A \* symbol indicates a device that may be damaged by static discharge.**

### ***How to Obtain Parts***

Electrical components may be ordered directly from the manufacturer by using the manufacturer's part number, or from the Fluke Corporation and its authorized representatives by using the part number under the heading FLUKE STOCK NO. In the U.S., order directly from the Fluke Parts Dept. by calling 1-800-526-4731. Parts price information is available from the Fluke Corporation or its representatives. Prices are also available in a Fluke Replacement Parts Catalog which is available on request.

In the event that the part ordered has been replaced by a new or improved part, the replacement will be accompanied by an explanatory note and installation instructions, if necessary.

To ensure prompt delivery of the correct part, include the following information when you place an order:

- Instrument model and serial number
- Part number and revision level of the pca containing the part.
- Reference designator
- Fluke stock number
- Description (as given under the DESCRIPTION heading)
- Quantity

## Manual Status Information

The Manual Status Information in Table 4-1 defines the assembly revision levels that are documented in the manual. Revision levels are printed on each pca.

Table 4-1. Manual Status Information

Ref. or Option No.	Assembly Name	Fluke Part No.	Revision Level
A1	PCB ASSEMBLY (FLUKE 12)	879002	M
A1	PCB ASSEMBLY (FLUKE 10/18)	878991	M
A1	PCB ASSEMBLY (FLUKE 7-300)	614963	M
A1	PCB ASSEMBLY (FLUKE 7-600)	614966	M

## Newer Instruments

Changes and improvements made to the instrument are identified by incrementing the revision letter marked on the affected pca. These changes are documented on a manual supplement sheet which, when applicable, is included with the manual.

## Parts Lists, Drawings, and Schematics

This section contains the parts lists, drawings, and schematics for the meters.

Note   
Ni-Cd

*This instrument may contain a Nickel-Cadmium battery. Do not mix with the solid waste stream. Spent batteries should be disposed of by a qualified recycler or hazardous materials handler. Contact your authorized Fluke service center for recycling information.*

### **Warning**

**To avoid fire or explosion, replace the fusible resistor only with Fluke PN 867361.**

**Table 4-2. Models 12B, 18, and 18/AL Final Assembly**

Reference Designator	Description	Fluke Stock Number	Total Quantity
A1	MAIN PCA (MODEL 12B)	879002	1
A1	MAIN PCA (MODEL 18)	878991	1
BT1	BATTERY, 9V, 0-15MA	696534	1
H1-4	SCREW, PH, P, AM THD FORM, STL, 5-14, .750	832246	4
J3	CONN, ELASTOMERIC, LCD TO PWB, 2.050 L	867247	1
J4	CONN, ELASTOMERIC, SWITCH TO PWB, .500 L	867242	1
MP2	CASE TOP, (PAD XFER & WINDOW, MODEL 12B)	614948	1
MP2	CASE TOP, (PAD XFER & WINDOW, MODEL 18)	614955	1
MP2	CASE TOP, (PAD XFER & WINDOW, MODEL 18/AL)	615192	1
MP5	ACTUATOR, SWITCH	203445	1
MP6	SUPPORT, SWITCH ASSEMBLY	879031	1
MP8	CASE, BOTTOM, YELLOW (MODEL 12B)	614864	1
MP8	CASE, BOTTOM, GRAY (MODEL 18)	614872	1
MP9	SHIELD, BOTTOM	878277	1
MP10	SHOCK ABSORBER	878983	1
MP11	FOOT, NON-SKID	885884	1
MP12	TEST LEADS	855742	1
S2	SWITCH ASSEMBLY (MODEL 12B)	614799	1
S2	SWITCH ASSEMBLY (MODEL 18)	614807	1
U3	LCD, 3.5 DIGIT, MULTIPLEXED	855226	1
TM1	12B/18 INSTRUCTION SHEET	602000	1

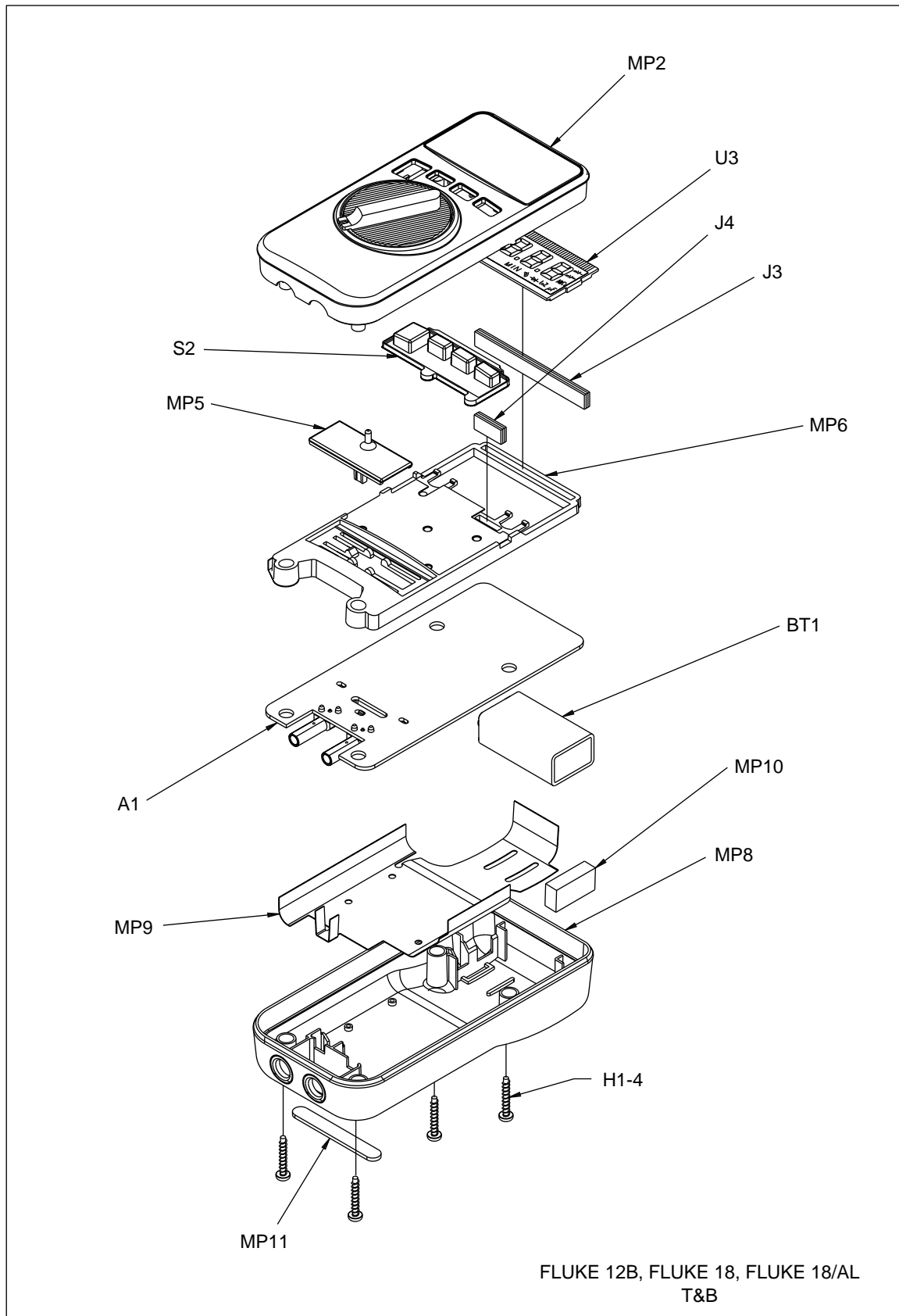

as06f.eps

Figure 4-1. Models 12B and 18 Final Assembly

**Table 4-3. Models 7-300 and 7-600 Final Assembly**

Reference Designator	Description	Fluke Stock Number	Total Quantity
A1	MAIN PCA (MODEL 7-600)	614966	1
A1	MAIN PCA (MODEL 7-300)	614963	1
BT1	BATTERY, 9V, 0-15MA	696534	1
H1-4	SCREW, PH, P, AM THD FORM, STL, 5-14, .750	832246	4
J3	CONN, ELASTOMERIC, LCD TO PWB, 2.050 L	867247	1
MP2	CASE TOP, (PAD XFER & WINDOW, MODEL 7-600)	614930	1
MP2	CASE TOP, (PAD XFER & WINDOW, MODEL 7-300)	614922	1
MP5	ACTUATOR, SWITCH	203452	1
MP6	SUPPORT, SWITCH ASSEMBLY	879031	1
MP8	CASE, BOTTOM, YELLOW	614864	1
MP9	SHIELD, BOTTOM	878277	1
MP10	SHOCK ABSORBER	878983	1
MP11	FOOT, NON-SKID	885884	1
MP12	TEST LEADS	855742	1
U3	LCD, 3.5 DIGIT, MULTIPLEXED	855226	1
TM1	INSTRUCTION SHEET, FLUKE 7	602018	1

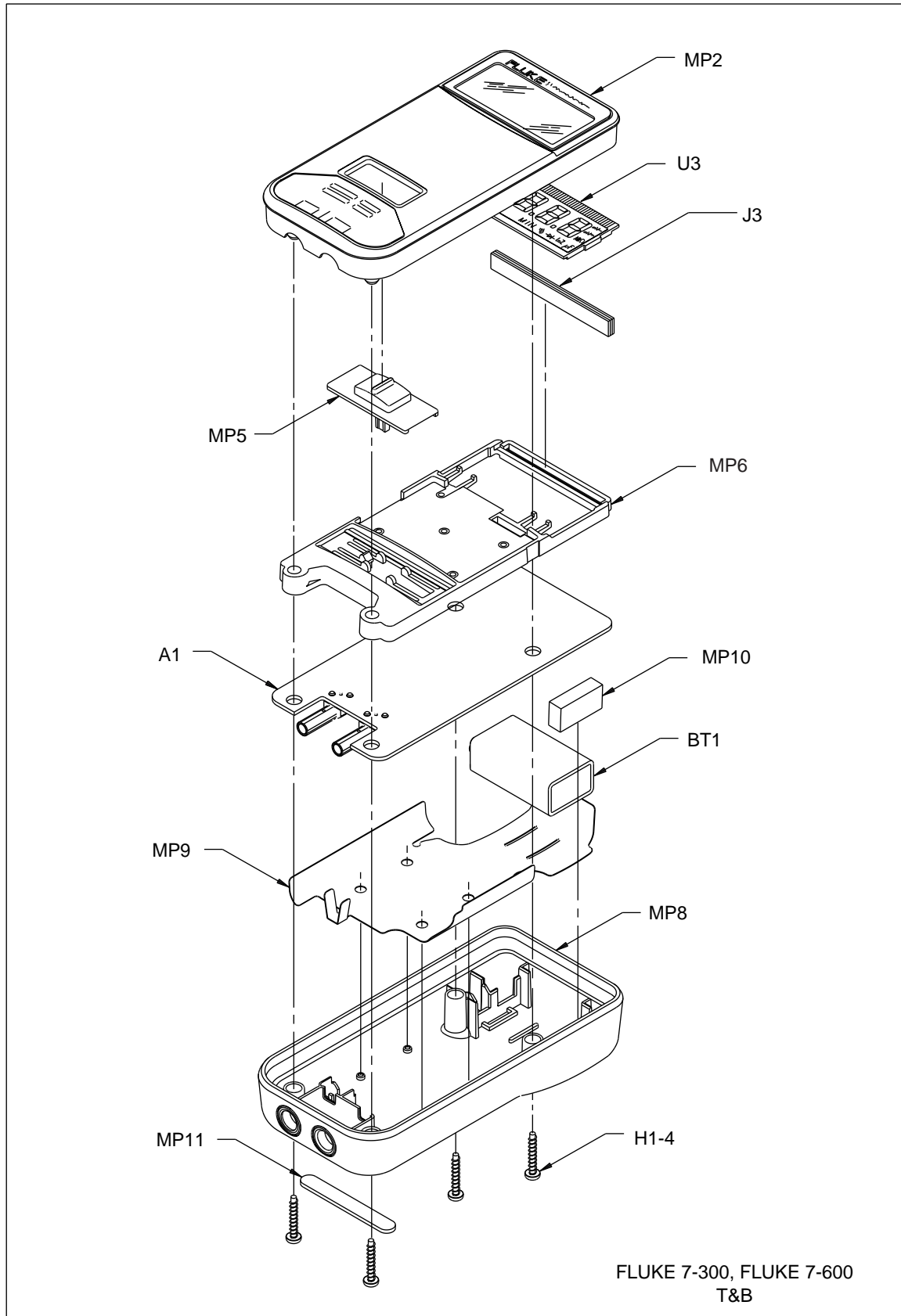

as09f.eps

Figure 4-2. Models 7-300 and 7-600 Final Assembly

**Table 4-4. A1 Main PCA**

Reference Designator	Description	Fluke Stock Number	Total Quantity			
			7-300	7-600	12B	18
C1	CAP, TA, 0.47 $\mu$ F, $\pm$ 20%, 35V	655035	1	1	1	1
C2, C5-7	CAP, POLYES, 0.022 $\mu$ F, $\pm$ 10%, 50V	715268	0	0	4	4
C2, C7	CAP, POLYES, 0.022 $\mu$ F, $\pm$ 10%, 50V	715268	2	2	0	0
C3	CAP, TA, 22 $\mu$ F, $\pm$ 20%, 6V, 6032	876545	1	1	1	1
C4, C13	CAP, CER, 0.1 $\mu$ F, $\pm$ 10%, 25V, X7R, 1206	747287	0	2	2	0
C4, C12, C13	CAP, CER, 0.1 $\mu$ F, $\pm$ 10%, 25V, X7R, 1206	747287	3	0	0	0
C4, C11, C13	CAP, CER, 0.1 $\mu$ F, $\pm$ 10%, 25V, X7R, 1206	747287	0	0	0	3
C5, C6	CAP, CER, 4700 PF, $\pm$ 20%, 100V	743427	2	2	0	0
C8	CAP, TA, 3.3 $\mu$ F, $\pm$ 20%, 16V, 3528	876552	1	1	1	1
C9	CAP, CER, 0.022 $\mu$ F, $\pm$ 10%, 50V, X7R, 1206	747279	1	1	1	1
C10	CAP, AL, 22 $\mu$ F, $\pm$ 20%, 10V, SOLV PROOF	887245	1	1	1	1
C14	CAP,POLY,.01 $\mu$ F, $\pm$ 10%,.1000V	822361	1	1	1	1
C15	CAP, TA, 47 $\mu$ F, $\pm$ 20%, 10V, 7343	867580	1	1	1	1
C16	CAP, CER, 10 PF, $\pm$ 20%, 50V, C0G	721589	1	1	1	1
CR1	DIODE, SI, 100 PIV, 1 AMP, SURFACE MOUNT	912451	1	1	1	1
CR2	DIODE,SI,DUAL, BV = 50V, IO = 100 mA, SOT-23	851659	1	1	1	1
CR3	DIODE,SI, BV = 70V, IO = 50 mA, DUAL, SOT-23	742320	1	1	1	1
E1	SURGE PROTECTOR,3750v, $\pm$ 20%	867361	1	1	1	1
J1, J2	RECEPTACLE, INPUT	878988	2	2	2	2
LS1	AF TRANSD, PIEZO, 20MM	876995	1	1	1	1
Q1	TRANSISTOR, SI, NPN, SELECT IEBO, SOT-23	821637	1	1	1	1
Q2	TRANSISTOR, SI, PNP, SELECT ICER, SOT-23	887179	1	1	1	1
R1	RES, CERM, 162K, $\pm$ 1%, .125W, 100 PPM, 1206	876198	1	1	1	1
R2	RES, MF, 332K, $\pm$ 1%, 0.125W, 100 PPM	655217	1	1	1	1
R3	RES, MF, 23.4K, $\pm$ 0.1%, 0.125W, 100 PPM	876292	1	1	1	1
R4	RES,VAR,CERM,25K, $\pm$ 25%,.2W	876300	1	1	1	1
R5	RES, CERM, 43.2K, $\pm$ 1%, .125W, 100 PPM, 1206	887109	1	1	1	1
R6	RES, CERM, 226K, $\pm$ 1%, .125W, 100 PPM, 1206	876524	1	1	1	1
R7-9, R23, R28	RES, CERM, 1M, $\pm$ 1%, .125W, 100 PPM, 1206	836387	5	5	5	5
R10	RES, CERM, 309K, $\pm$ 1%, .125W, 100 PPM, 1206	876201	1	1	1	1
R11, R12	RES, MF, 30.1K, $\pm$ 0.1%, 0.125W, 100 PPM	887161	2	2	2	2
R13	RES, MF, 27.1K, $\pm$ 0.1%, 0.125W, 100 PPM	876289	1	1	1	1
R14, R15	RES, CERM, 10K, $\pm$ 5%, .125W, 200 PPM, 1206	746610	2	2	2	2
R16, R18	RES,CERM, 470, $\pm$ 5%,3W	887117	2	2	2	2
R17	RES,CERM, 1M, $\pm$ 5%,1W	912589	1	1	1	1
R19	RES, MF, 450, $\pm$ 10%,	107398	1	1	1	1
R21	RES JUMPER, 0.02, 0.25W	682575	1	1	1	1
R22, R29, R30	RES, CERM, 300, $\pm$ 5%, .125W, 200 PPM, 1206	746362	3	3	3	3
R24	RES, CERM, 487K, $\pm$ 1%, .125W, 100 PPM, 1206	887112	1	1	1	1
R25	RES, CERM, 2.2M, $\pm$ 5%, .125W, 200 PPM, 1206	811778	1	1	1	1



Table 4-4. A1 Main PCA (cont)

Reference Designator	Description	Fluke Stock Number	Total Quantity			
			7-300	7-600	12B	18
R26	RES, CERM, 100K, $\pm 1\%$ , .125W, 100 PPM, 1206	769802	1	1	1	1
R27	RES, CERM, 0, +.05 MAX, .125W, 1206	810747	1	1	1	1
RT1	THERM, POS 1.1K, $\pm 20\%$ , 25C	867192	1	1	1	1
S1	SWITCH, SLIDE, 3 POS, 5 PIN	868117	1	1	1	1
U1	ARTIC, ASSEMBLY TESTED	858472	1	1	1	1
U2	IC, CMOS, 4 BIT MPU, LCD	601575	1	1	0	0
U2	*IC, CMOS, 4 BIT MPU, LCD CNTRLR, 80PNQFP	866913	0	0	1	1
VR1	IC, 1.23V, 150 PPM T.C., BANDGAP V. REF	634451	1	1	1	1
XBT, XBT2	CONTACT, BATTERY	890327	2	2	2	2
Y1	RESONATOR, CERAMIC, PIEZOELEC, 2.10 MHZ	876024	1	1	1	1
Z1	RES NET THK FILLM TESTED	872234	1	1	1	1



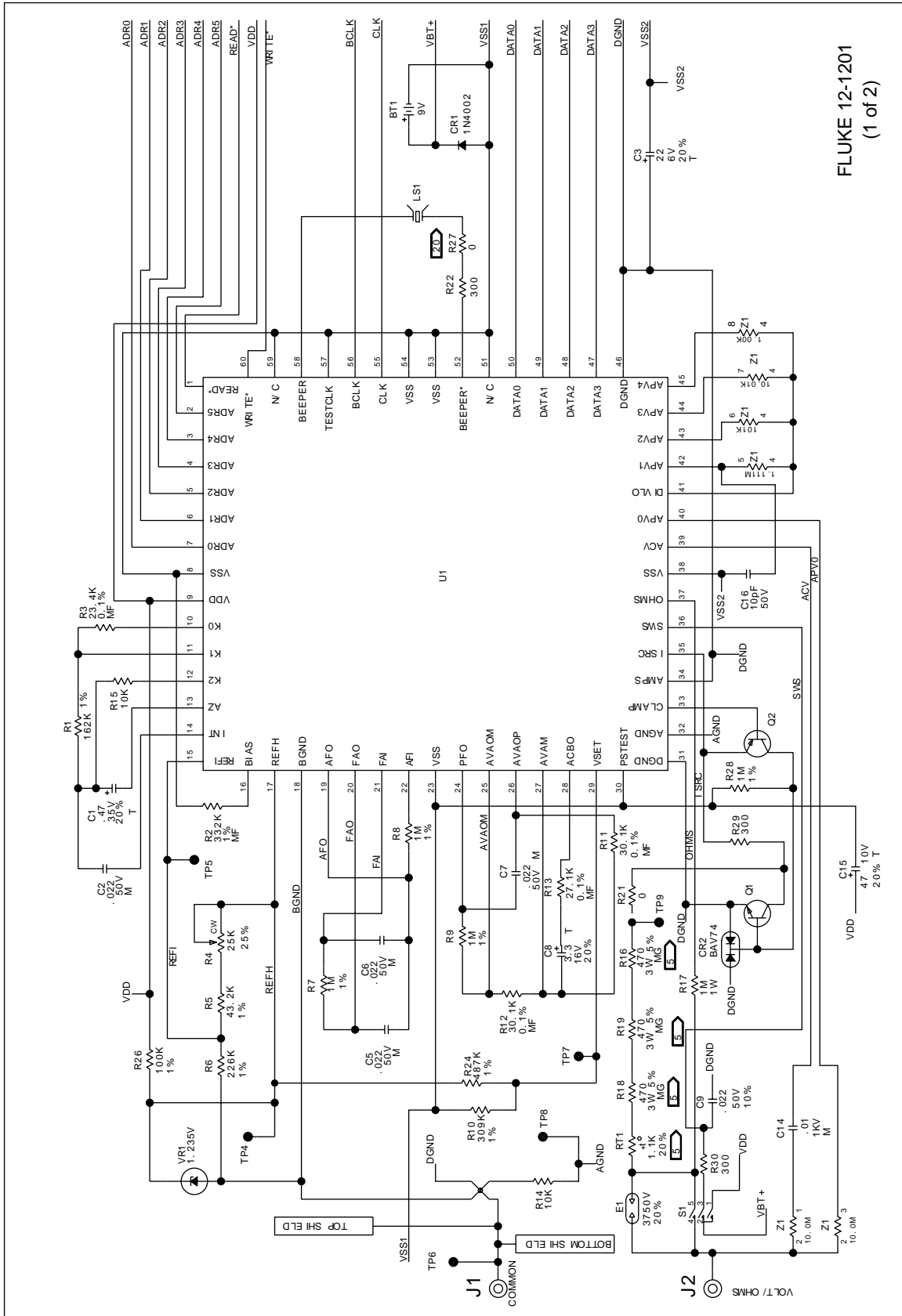

FLUKE 12-1201  
(1 of 2)

Figure 4-4. Model 12B Schematic

as20f.eps

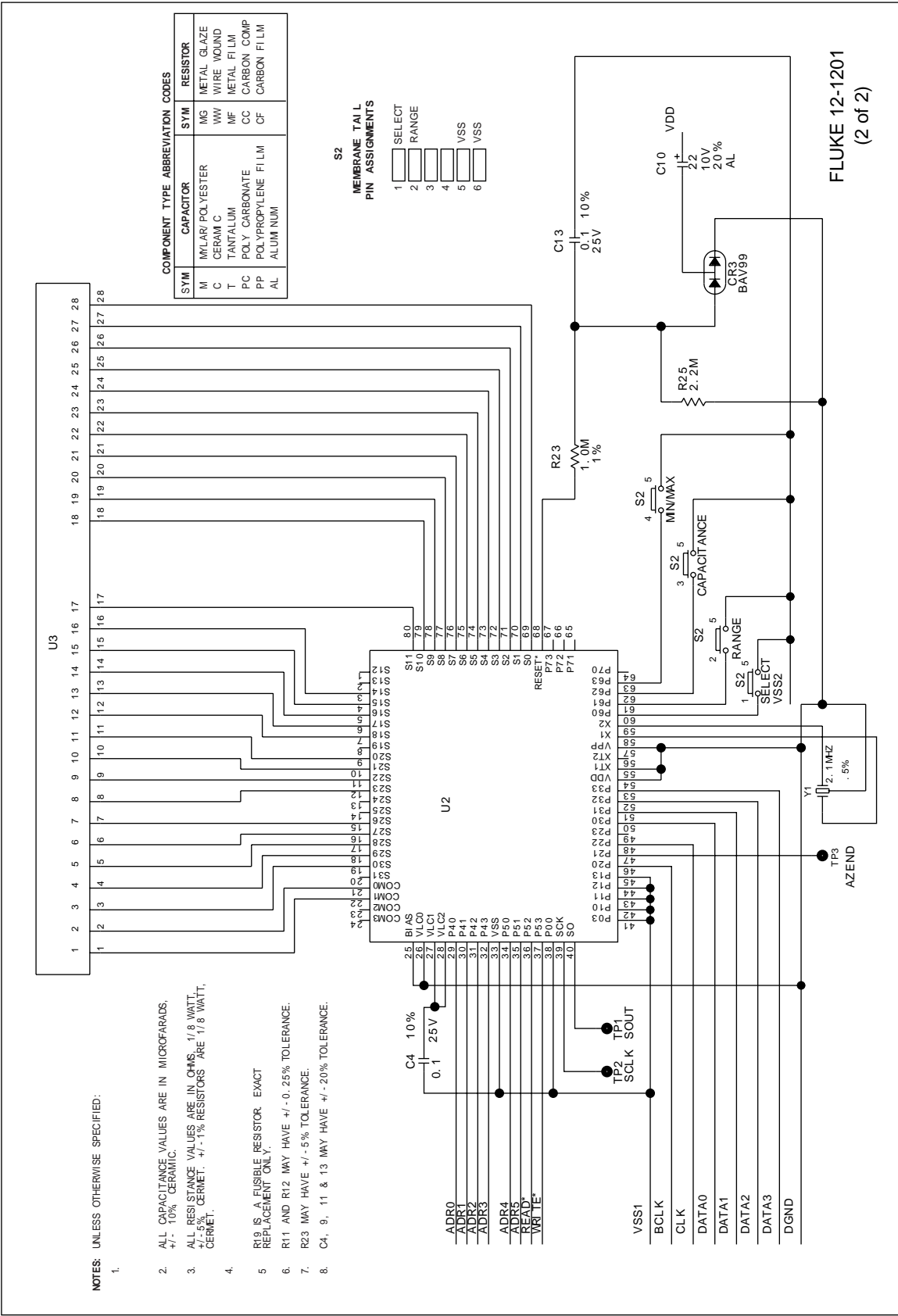
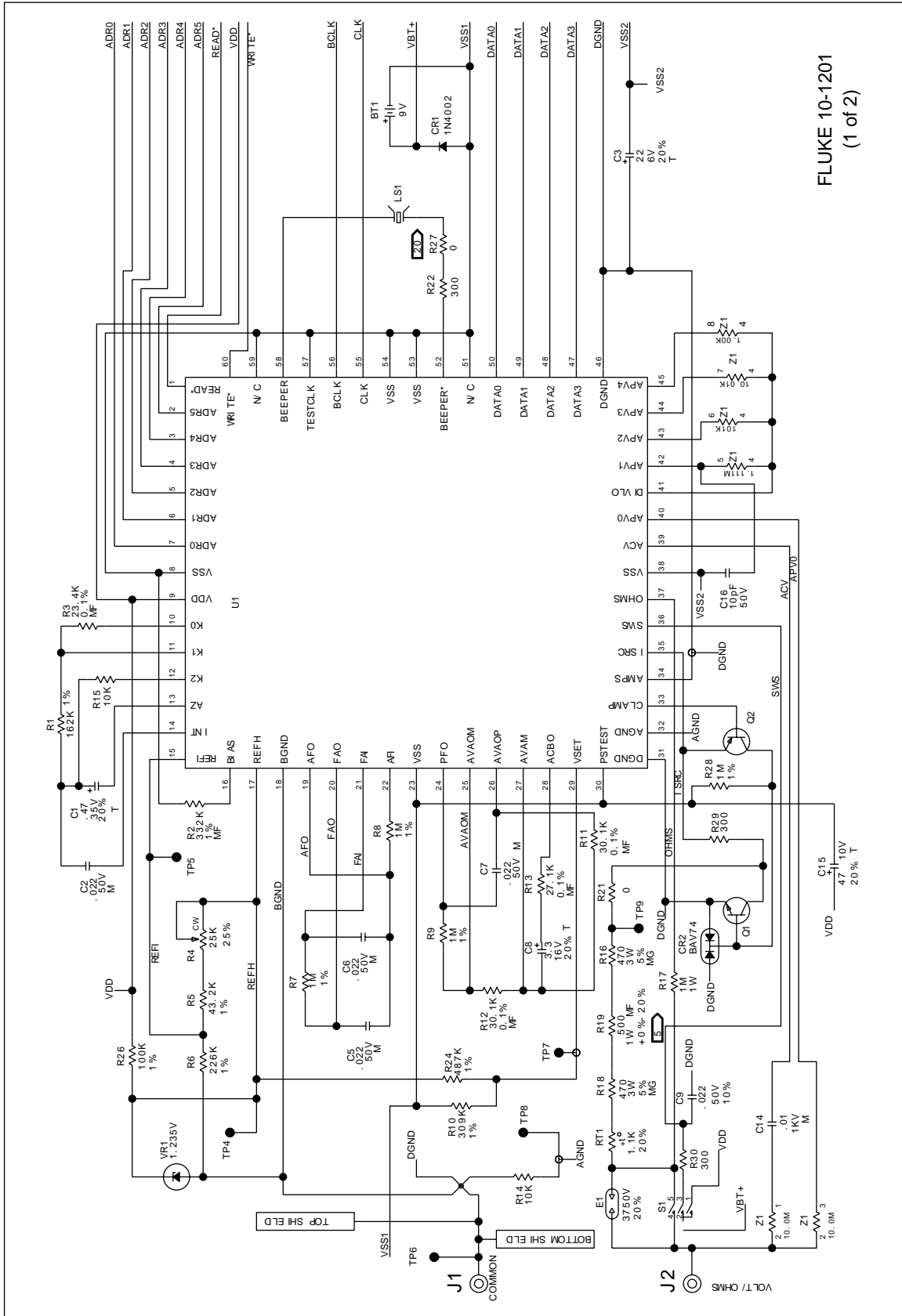

Figure 4-4. Model 12B Schematic (cont)

as21f.eps



FLUKE 10-1201  
(1 of 2)

Figure 4-5. Model 18 Schematic

as16f.eps

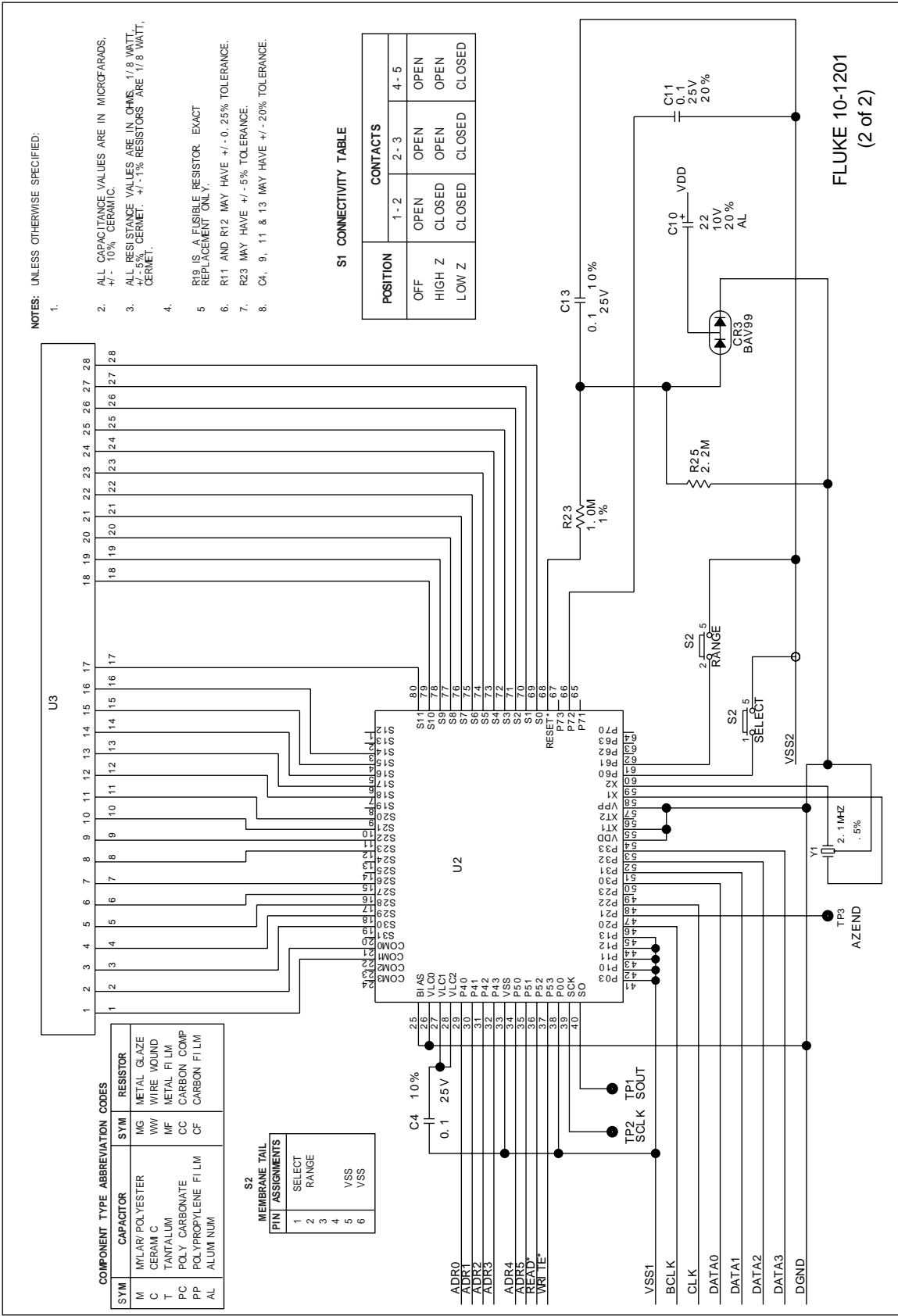

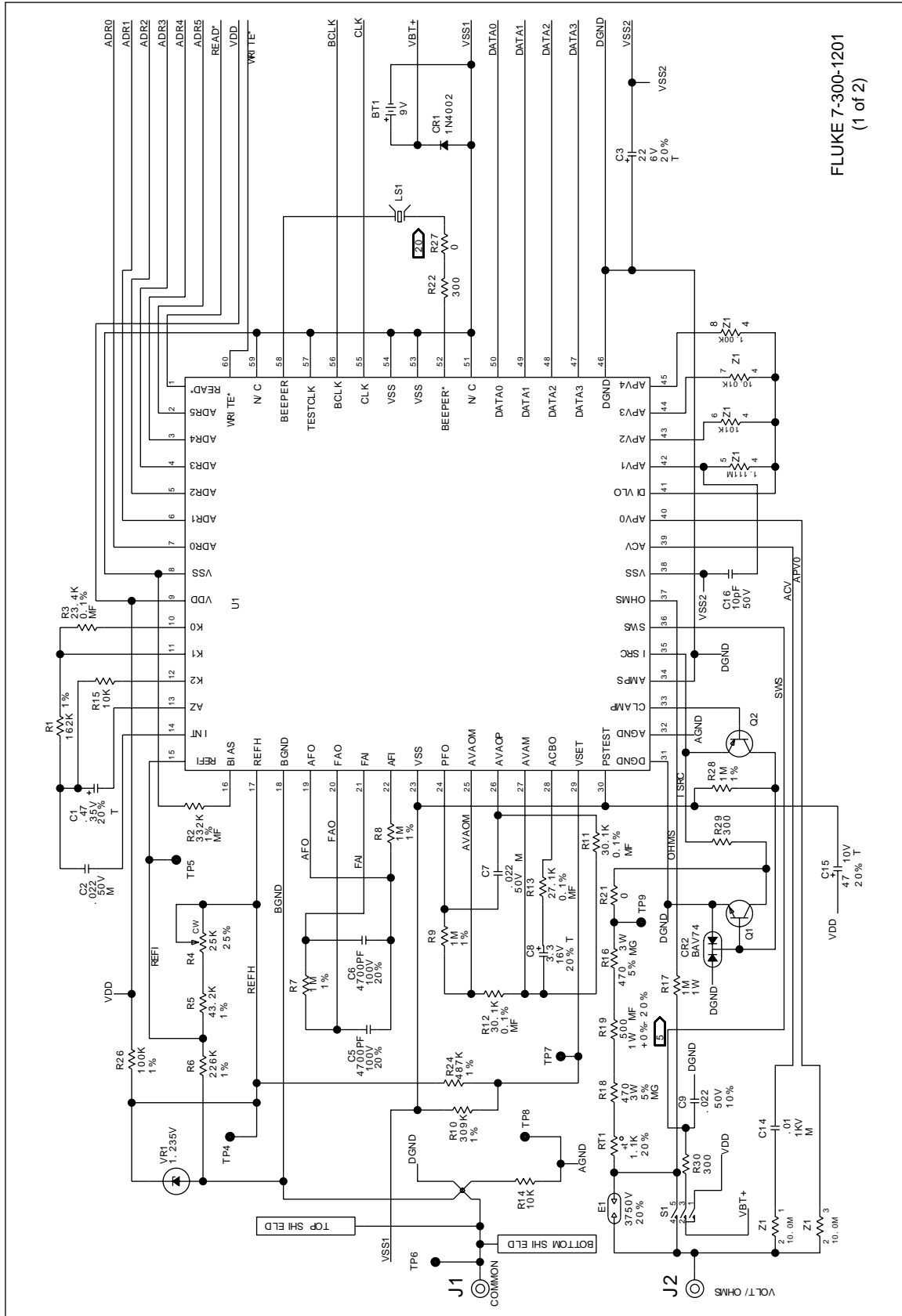

FLUKE 7-300-1201  
(1 of 2)

Figure 4-6. Model 7-300 Schematic

as12f.eps

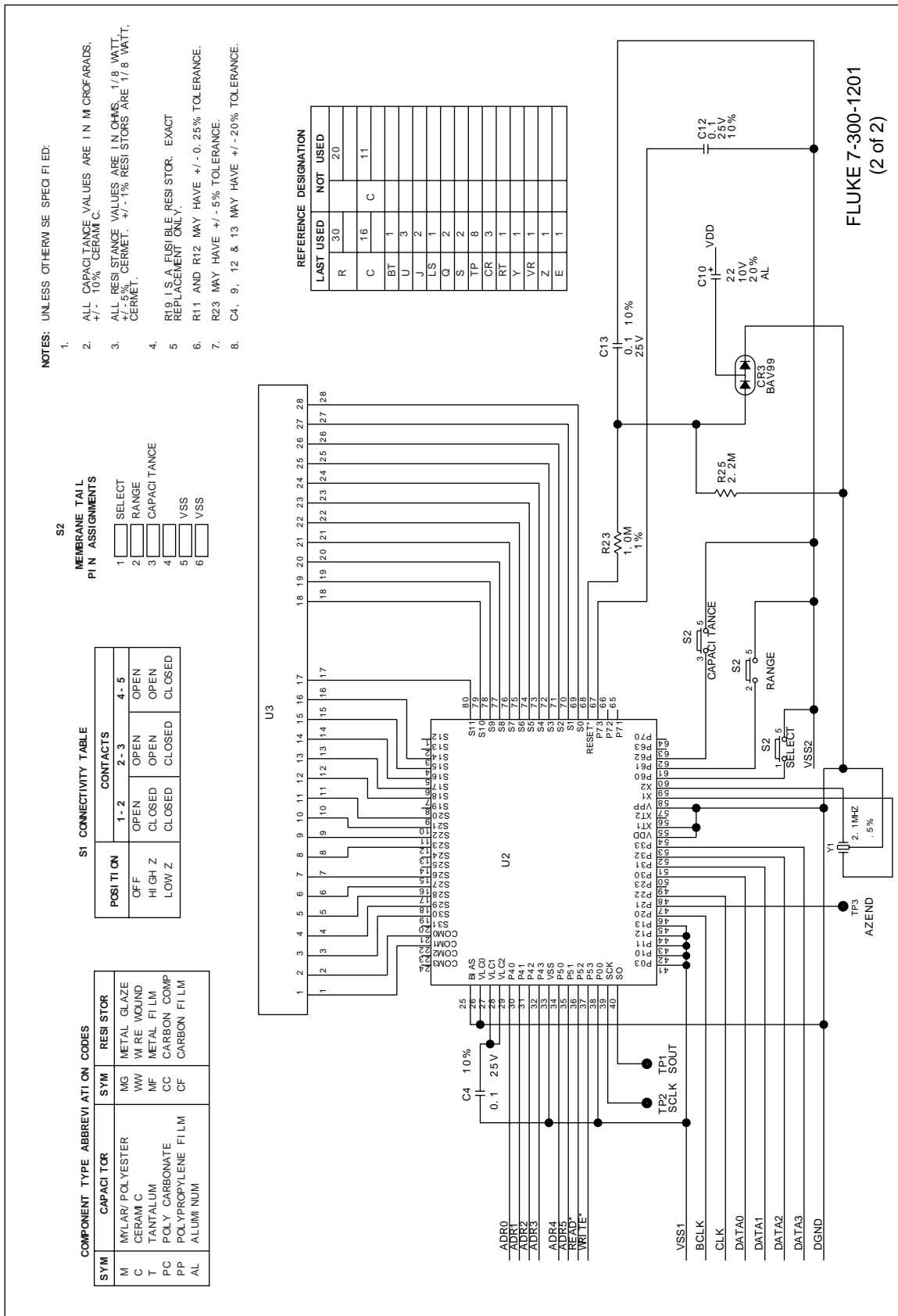
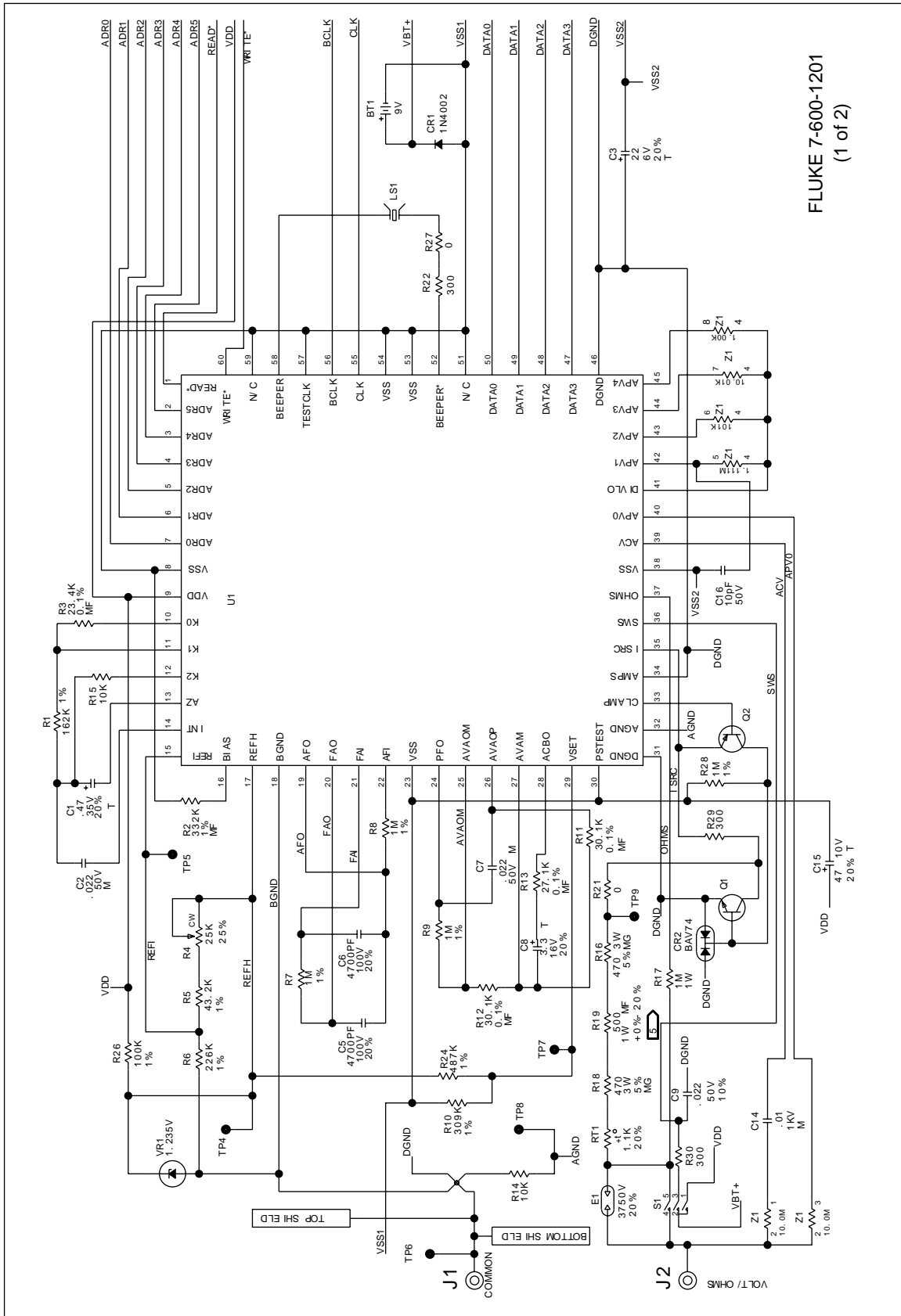

Figure 4-6. Model 7-300 Schematic (cont)

as13f.eps





FLUKE 7-600-1201  
(1 of 2)

Figure 4-7. Model 7-600 Schematic

as18f.eps

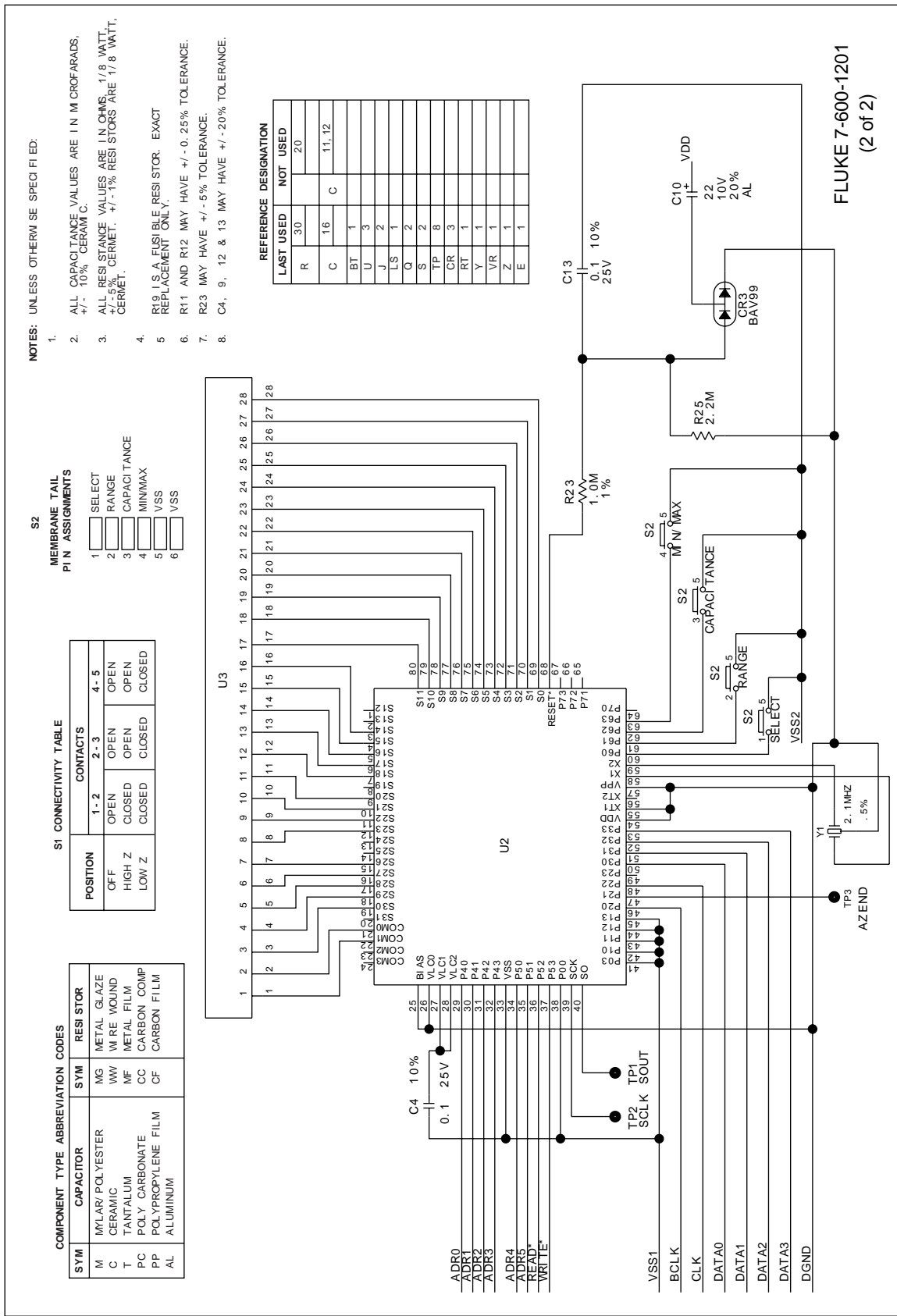

Figure 4-7. Model 7-600 Schematic (cont)

as19f.eps



## Service Centers

USA	INTERNATIONAL			
<p><b>California</b>                      FLW                      Fluke Calibration Center                      C/o FLW Service Corporation                      3505 Cadillac Ave., Bldg E                      Costa Mesa, CA 92626                      TEL: (714) 751-7512                      FAX: (714) 755-7332</p> <p><b>Dallas</b>                      Fluke Service Center                      2104 Hutton Drive                      Suite 112                      Carrollton, TX 75006                      TEL: (214) 406-1000                      FAX: (214) 247-5642</p> <p>Fluke Service Center                      42711 Lawrence Place                      Fremont, CA 94538                      TEL: (510) 651-5112                      FAX: (510) 651-4962</p> <p><b>Illinois</b>                      Fluke Service Center                      1150 W. Euclid Avenue                      Palatine, IL 60067                      TEL: (708) 705-0500                      FAX: (847) 705-9989</p> <p><b>New Jersey</b>                      Fluke Service Center                      W. 75 Century Rd                      Paramus, N.J. 07652-0930                      TEL: (201) 599-9500 (599-0919)                      FAX: (201) 599-2093</p> <p><b>Washington</b>                      Fluke Service Center                      Fluke Corporation                      Building #4                      1420 - 75TH St. S.W.                      Everett WA 98203                      TEL: (206) 356-5560                      FAX: (206) 356-6390</p>	<p><b>Australia</b>                      Phillips Sci. and Ind., Pty., L.                      745 Springvale Road                      Mulgrave                      Victoria 3170                      TEL: 61-3-881-3666                      FAX: 61-3-881-3636</p> <p>Phil. Sci. &amp; Ind. Blk F, Centrecr.                      34 Waterloo Road                      North Ryde, N.S.W. 2113                      TEL: 61-2-888-8222                      FAX: 61-2-888-0440</p> <p><b>Austria</b>                      Fluke Vertriebsges. GMBH (GM)                      SudrandstraBe 7                      P.O. Box 10, A-1232 Vienna                      TEL: 43-1-614-100                      FAX: 43-1-614-1010</p> <p><b>Bahrain</b>                      Mohammed Fakhro &amp; Bros.                      P.O. Box 439                      Bahrain                      TEL: 973-253529                      FAX: 973-275996</p> <p><b>Belgium</b>                      N.V. Fluke Belgium S.A.                      Sales &amp; Service Dept.                      Langeveldpark - Unit 5 &amp; 7                      P.Basteleusstraat 2-4-6                      1600 St. Pieters - Leeuw                      TEL: 218-2-331-2777 (ext 218)                      FAX: 32-2-331-1489</p> <p><b>Bolivia</b>                      Casilla 7295,                      Calle Ayacucho No. 208                      Edificio Flores, 5to. Piso                      La Paz, Bolivia                      TEL: 591-2-317531 or 317173                      FAX: 591-2-317545</p> <p><b>Brazil</b>                      Philips Medical Systems, LTDA                      Av. Interlagos North                      3493 - Campo Grande                      04661-200 Sao Paulo S.P.                      TEL: 55-11-523-4811                      FAX: 55-11-524-4873 (ID 2148)</p> <p>Sigtron Instrumentos E. Servicios                      Rua Alvaro Rodrigues                      269 - Brooklin                      Sao Paulo, Sp                      TEL: 55-11-240-7359                      FAX: 55-11-533-3749</p> <p>Sistest                      Sist. Instr. Testes Ltda                      Av. Ataulfo De Paiva                      135 S/ 1117 - Leblon 22.449-900                      Rio De Janeiro, Rj, Brazil                      TEL: 55-21-259-5755 or 512-3679                      FAX: 55-21-259-5743</p>	<p><b>Bulgaria</b>                      Ac Sophilco, Cust. Supp. Serv.                      P.O. Box 42                      1309 Sofia, Bulgaria                      TEL: 359-2-200785                      FAX: 359-2-220910</p> <p><b>C.S.F.R.</b>                      Elso                      NA. Berance 2                      16200 Prague 6                      TEL: 42-2-316-4810                      FAX: 42-2-364986</p> <p>Data Elektronik BRNO                      Jugoslavaska 113                      61300 Brno                      TEL: 42-5-57400-2                      FAX: 42-5-574002</p> <p><b>Canada</b>                      Fluke Electronics Canada Inc.                      400 Britannia Rd East, Ut #1                      Mississauga, Ontario                      L4Z 1X9                      TEL: 905-890-7600                      FAX: 905-890-6866</p> <p><b>Chile</b>                      Intronica, Instrumen Electronica,                      S.A.C.I.                      Guardia Vieja 181 Of. 503                      Casilla 16500, Santiago 9                      TEL: 56-2-232-6700</p> <p><b>China</b>                      Fluke S.C., Room 2111                      Scite Tower                      Jianguomenwai Dajie                      Beijing 100004, PRC                      TEL: 86-10-512-6351,6319, 3437                      FAX: 86-10-512-3437</p> <p><b>Colombia</b>                      Sistemas E Instrument., Ltda.                      Calle 83, No. 37-07                      Po Box 29583                      Santa Fe De Bogota                      TEL: 57-1-287-5424                      FAX: 57-1-218-2660</p> <p><b>Costa Rica</b>                      Electronic Engineering, S.A.                      Carretera de Circunvalacion                      Sabanilla Av. Novena                      P.O. Box 4300-1000, San Jose                      TEL: 506-253-3759 or 225-8793                      FAX: 506-225-1286</p> <p><b>Croatia</b>                      Kaltim - Zagreb                      Fluke Sis &amp; Serv. Draga 8                      41425 Sveta Jana                      TEL: 385-41-837115                      FAX: 385-41-837237</p> <p><b>Denmark</b>                      Fluke Danmark A/S, Cust. Supp.                      Ejby Industrivej 40                      DK 2600 Glostrup                      TEL: 45-43-44-1900 or 1935                      FAX: 45-43-43-9192</p>	<p><b>Ecuador</b>                      Proteco Coasin Cia., Ltda.                      Av. 12 de Octubre 2449 y                      Orellana                      P.O. Box 17-03-228-A, Quito                      TEL: 593-2-230283 or 520005                      FAX: 593-2-561980</p> <p><b>Egypt</b>                      EEMCO                      Electronic Equipment Mktng Co.                      9 Hassan Mazher St.                      P.O. Box 2009                      St. Heliopolis 11361                      Cairo, Egypt                      TEL: 20-2-417-8296                      FAX: 20-2-417-8296</p> <p><b>Fed. Rep. of Germany</b>                      Fluke Deutschland Gmbh                      Customer Support Services                      Servicestutzpunkt VFN5                      Oskar-Messter-Strasse 18                      85737 Ismaning/Munich                      TEL: 49-89-9961-1260                      FAX: 49-89-9961-1270</p> <p>Fluke Deutschland                      (CSS), Servicestutzpunkt VFN5                      Meindorfer Strasse 205                      22145 Hamburg                      TEL: 49-40-679-6434                      FAX: 49-40-679-7653</p> <p><b>Finland</b>                      Fluke Finland Oy                      Sinikalliontie 3, P.L. 151                      SF 02631 Espoo                      TEL: 358-0-6152-5600                      FAX: 358-0-6152-5630</p> <p><b>France</b>                      Fluke France S.A.                      37 Rue Voltaire                      BP 112, 93700 Drancy, Cedex                      TEL: 33-1-4896-6300                      FAX: 33-1-4896-6330</p> <p><b>Greece</b>                      Philips S.A. Hellenique                      Fluke Sales &amp; Service Manager                      15, 25th March Street, P.O. Box                      3153, 177 78 Tavros Athens                      TEL: 30-1-489-4911 or 4262                      FAX: 30-1-481-8594</p> <p><b>Hong Kong</b>                      Schmidt &amp; Co, Ltd. 1st Floor                      323 Jaffe Road                      Wanchai                      TEL: 852-9223-5623                      FAX: 852 834-1848</p> <p><b>Hungary</b>                      MTA MMSZ KFT, Srv. / Gen. Mgr                      Etele Ut. 59-61                      P.O. Box 58                      H 1502 Budapest                      TEL: 361-186-9589 or 209-3444                      FAX: 361-161-1021</p>	<p><b>Iceland</b>                      Taeknival HF                      P.O. Box 8294, Skeifunni 17                      128 Reykjavik                      TEL: 354-1-681665                      FAX: 354-1-680664</p> <p><b>India</b>                      Hinditron Services Pvt. Inc.                      33/44A 8th Main Road                      Raj Mahal Vilas Extension                      Bangalore 560 080                      TEL: 91-80-334-8266 or 0068                      FAX: 91-33-247-6844</p> <p>Hinditron Services Pvt. Ltd                      Hinditron House, 23-B                      Mahal Industrial Estate                      Mahakali Caves Rd, Andheri East                      Bombay 400 093                      TEL: 91-22-836-4560, 6590                      FAX: 91-22-836-4682</p> <p>Hinditron Services Pvt. Ltd                      Castle House, 5th Floor                      5/1 A, Hungerford Street                      Calcutta 700 017                      TEL: 91-33-400-194                      FAX: 91-33-247-6844</p> <p>Hinditron Services Pvt. Ltd                      204-206 Hemkunt Tower                      98 Nehru Place                      New Delhi 110 019                      TEL: 91-11-641-3675 or 643-0519                      FAX: 91-11-642-9118</p> <p>Hinditron Services Pvt. Ltd.                      Field Service Center                      Emerald House, 5th Floor                      114 Sarojini Devi Road                      Secunderabad 500 003                      TEL: 91 40-844033 or 843753                      FAX: 91-40-847585</p> <p><b>Indonesia</b>                      P. T. Daeng Bro, Phillips House                      J/n H.R. Rasuna Said Kav. 3-4                      Jakarta 12950                      TEL: 62-21-520-1122                      FAX: 62-21-520-5189 or 62-21-520-5189</p> <p><b>Israel</b>                      R.D.T Equipment &amp; Sys, Ltd.                      P.O. Box 58072                      Tel-Aviv 61580                      TEL: 972-3-645-0745                      FAX: 972-3-647-8908</p> <p><b>Italy</b>                      Fluke Italia S.R.L., CSS                      Viale Delle Industrie, 11                      20090 Vimodrone (MI)                      TEL: 39-2-268-434-203 or 4341                      FAX: 39-2-250-1645</p>

## Service Centers (cont)

<p><b>Japan</b> Fluke Corp., Sumitomo Higashi Shinbashi Bldg. 1-1-11 Hamamatsucho Minato-ku, Tokyo 105 TEL: 81-3-3434-0188 or 0181 FAX: 81-3-3434-0170</p>	<p><b>Nigeria</b> Philips Projects Centre Resident Delegate / PMB 80065 8, Kofo Abayomi Street Victoria Island, Nigeria TEL: 234-1-262-0632 FAX: 234-1-262-0631</p>	<p><b>Singapore</b> Fluke Singapore Pte., Ltd. Fluke ASEAN Regional Office #27-03 PSA Building 460 Alexandra Road Singapore 119963 TEL: 65-276-5161 FAX: 65-276-5929</p>	<p><b>United Kingdom</b> Fluke U.K. LTD. (CSS) Colonial Way Watford, Hertfordshire WD2 4TT TEL: 44-923-240511 FAX: 44-923-225067</p>
<p><b>Kenya</b> Walterfang P.O. Box 14897 Nairobi, Kenya TEL: 254-2 FAX: 254-2</p>	<p><b>Norway</b> Fluke Norway A/S, Cust. Support P.O. Box 6054 Etterstad N-0601 Oslo TEL: 47-22-653400 FAX: 47-22-653407</p>	<p><b>South Africa</b> Spescom Measur. (PTY) Ltd. Spescom Park Cm. Alexandra Rd. &amp; Second St. Halfway House, Midrand 1685 TEL: 27-11-315-0757 FAX: 27-11-805-1192</p>	<p><b>Uruguay</b> Coasin Instrumontos S.A. Casilla de Correo 1400 Libertad 2529, Montevideo TEL: 598-2-492-436, 659 FAX: 598-2-492-659</p>
<p><b>Korea</b> B&amp;P International Co., Ltd. Geopung Town A-303 203-1 Nonhyun-Dong Kangnam-Ku Seoul 135-010 TEL: 82 12 546-1457 FAX: 82 12 546-1458</p>	<p><b>Pakistan (Philips)</b> Philips Elec. Ind. of Prof. Sys. Div. Islamic Cham. of Commerce St-2/A, Block 9, KDA Scheme 5, Clifton, Karachi-75600 TEL: 92-21-587-4641 or 4649 FAX: 92-21-577-0348</p>	<p><b>Spain</b> Fluke Iberica S.L. Centro Empresarial Euronora c/Ronda de Poniente, 8 28760-Tres Cantos Madrid, Spain TEL: 34-1-804-2301 FAX: 34-1-804-2496</p>	<p><b>Venezuela</b> Coasin C.A. Calle 9 Con Calle 4, Edif. Edinurbi Piso-3 La Urbina Caracas 1070-A, Venezuela TEL: 58-2-241-6214 FAX: 58-2-241-1939</p>
<p>IL MYOUNG, INC. Youngdong P.O. Box 1486 780-46, Yeogsam-Dong Kangnam-Ku, Seoul TEL: 82 2 552-8582-4 FAX: 82 2 553-0388</p>	<p><b>Peru</b> Impor. &amp; Repres. Electronicas S.A., JR. Pumacahua 955 Lima 11 TEL: 51-14-23-5099 FAX: 51-14-31-0707</p>	<p><b>Sweden</b> Fluke Sverige AB, (CSS) P.O. Box 61 S-164 94 Kista TEL: 46-8-751-0235 or 0230 FAX: 46-8-751-0480</p>	<p><b>Vietnam</b> Schmidt-Vietnam Co., Ltd. 8/FI. Schmidt Tower Hanoi International Tech. Ctr KMB, Highway 32, Cau Giay Tu Liem, Hanoi Vietnam TEL: 84-4-346186 or 346187 FAX: 84-4-346-188</p>
<p><b>Kuwait</b> Yusuf A. Alghanim &amp; Sons W.L.L. P.O. Box 223 Safat Alghanim Industries Airport Road Shuwaikh 13003 Kuwait TEL: 965-4842988 FAX: 965-4847244</p>	<p><b>Philippines</b> Spark Electronics Corp. P.O. Box 610, Greenhills Metro Manila 1502 TEL: 63-2-700-621 FAX: 63-2-721-0491 or 700-709</p>	<p><b>Switzerland</b> Fluke Switzerland AG, (CSS) Rutistrasse 28 CH 8952 Schlieren Switzerland TEL: 41-1-730-3310 or 730-3932 FAX: 41-1-730-3932</p>	<p><b>West Indies</b> Western Scientific Co., Ltd. Freeport Mission Road Freeport, Trinidad West Indies TEL: 809-673-0038 FAX: 809-673-0767</p>
<p><b>Malaysia</b> CNN. SDN. BHD. 17D, 2nd Floor Lebuhraya Batu Lancang Taman Seri Damai 11600 Jelutong Penang TEL: 60-4-657-9584 FAX: 60-4-657-0835</p>	<p><b>Poland</b> Elec. Instr. Srv. Philips Cons. UL. Malechowska 6 60 188 Poznan TEL: 48-61-681998 FAX: 48-61-682256</p>	<p><b>Taiwan</b> Schmidt Scientific Taiwan, Ltd. 6th Floor, No. 109, Tung Hsing Street Taipei, Taiwan R.O.C. TEL: 886-2-767-8890 or 746- 2720 FAX: 886-2-767-8820</p>	<p><b>Yugoslavia</b> Jugoelektro Beograd T &amp; M Customer Support Services Knez Mihailova 33 11070 Novi TEL: 38-11-182470 FAX: 38-11-638209</p>
<p><b>Mexico</b> Metro. Y Calibraciones Ind., S.A. Diagonal No. 17 - 3 Piso Col. Del Valle C.P. 03100, Mexico D.F. TEL: 52-5-682-8040 FAX: 52-5-687-8695</p>	<p><b>Portugal</b> Fluke Iberica S.L. Sasles Y Services Dept Campo Grande 35 - 7b 1700 Llsboa TEL: 351-1-795-1712 FAX: 351-1-795-1713</p>	<p><b>Thailand</b> Measuretronix Ltd. 2102/31 Ramkamhang Road Bangkok 10240 TEL: 66-2-375-2733 or 2734 FAX: 66-2-374-9965</p>	<p><b>Zimbabwe</b> Field Technical Sales 45, Kelvin Road North P.O. Box Cy535 Causeway Harare, Zimbabwe TEL: 263-4-750381 or 750382 FAX: 263-4-729970</p>
<p><b>Netherlands</b> Fluke Nederland B.V. (CSS) Afdeling Service Science Park Eindhoven 5108 5692 EC Son TEL: 31-40-2678 FAX: 31-40-2678</p>	<p><b>Romania</b> Ronex S.R.L., Cust. Supp. Serv. Str. Transilvaniei Nr. 24 70778 Bucharest - I TEL: 40-1-614-3597 or 3598 FAX: 40-1-659-4468</p>	<p><b>Turkey</b> Pestas Prof. Elektr. Sist. Tic. V Selcuklar Caddesi Meydan Apt. No. 49, Daire 23 Akatlar 80630 Istanbul TEL: 90-212-282-7838 FAX: 90-212-282-7839</p>	
<p><b>New Zealand</b> Phillips Scientific &amp; Ind., Pty., L. Private Bag 41904, St. Lukes, 2 Wagener Place Mt. Albert, Auckland 3 TEL: 64-9-894-4160 FAX: 64-9-849-7814</p>	<p><b>Russia</b> Infomedia UL. Petrovsko Razumovsky Proezd. 29 103287 Moscow TEL: 7-95-212-3833 FAX: 7-95-212-3838</p>	<p><b>U.A.E.</b> Haris Al Afaq Ltd. P.O. Box 8141 Dubai TEL: 971-4-283623 or 283624 FAX: 971-4-281285</p>	
	<p><b>Saudi Arabia</b> A. Rajab &amp; Silsilah Co. S&amp;S Dept. P.O. Box 203 21411 Jeddah TEL: 966-2-661-0006 FAX: 966-2-661-0558</p>		